

# Washington State Community and Technical Colleges Mathematics Pathways Packet



Developed by  
Dr. Pat Averbek  
August, 2019

## Introduction to Mathematics Pathways Packet

In 2013, the Direct Transfer Agreement [DTA] between the Community and Technical Colleges [CTC] and the four-year colleges and universities was modified, allowing CTC mathematics faculty the opportunity to address their students' needs in their precollege math programs. Due to the relative independence of colleges within the CTC system, math faculty had flexibility in designing their college's precollege math programs to offer opportunities for students beyond the single pathway to all of the entry college-level math courses.

The Mathematics Pathways Packet describes the course offerings in each of the math programs at the CTCs in Washington State. A common flowchart was developed in order to illustrate more readily the various models that CTCs have utilized to help their students gain access to college-level math courses that transfer to four-year institutions.

This packet consists of flowcharts for each of the CTCs' math programs for 2019-20. This packet is an updated version of the work completed in 2017 for which examinations of the CTCs websites and course catalogs were conducted to gather initial information about the CTCs math programs. Interviews with faculty and staff at the CTCs were performed to clarify and confirm the flowcharts that were developed.

Each of the flowcharts illustrates the pathways within all of the CTCs' precollege math programs. The pathways are defined by the college level math courses that match up with the courses required in the DTA: Liberal Arts, Statistics, Elementary Education, Business, and STEM. The pathways within the precollege math program are color coded to match the college level math courses. Thus, by identifying the college level course that is needed for a student, one can follow the path from the precollege course where the student initially places to the desired college level course.

Math placement information is provided for each of the CTCs in a chart with each CTC flowchart. Six common methods have been identified for math placement of students: placement test, high school transcript, reciprocity, prior math class, SAT/ACT, and Smarter Balance. The chart also gives the length of time the placement is valid as determined by the college.

Lastly, within the flowcharts of the four-year colleges and universities, information about equivalency of CTC courses and credits for AP and IB testing is provided. The number of CTCs that have the corresponding course designated as equivalent to the four-year institution's course is included in the flowchart. Since credit for AP and IB testing is determined by the four-year institutions for CTCs transfer students, a chart of the four-year institution's credits for scores on the AP and IB test is provided.

I would like to thank Edmonds Community College, the Dana Center, and SBCTC for their support in making this packet.



Dana Center  
**Mathematics**  
PATHWAYS

WASHINGTON STATE COMMUNITY  
AND TECHNICAL COLLEGES

**Math Pathways**  
to Completion



# Legend

## Flowcharts for CTCs

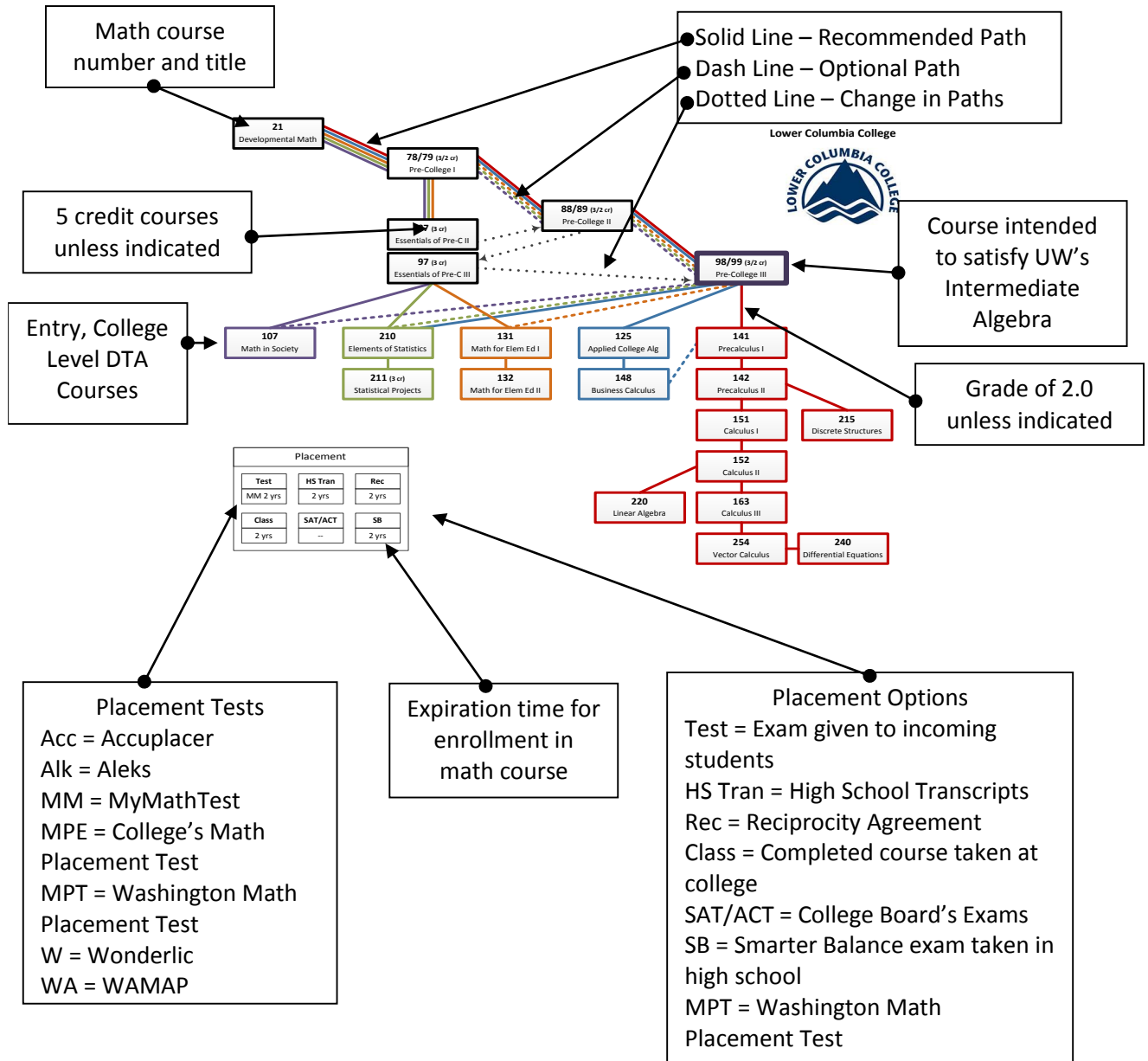

# Flowcharts for Universities

Credit designations for AP and IB tests.

AP/IB Credit		
AP-AB	3,4,5	M172
AP-BC	3,4,5	M172&M173
AP-Stats	3,4,5	M311
IB	--	--

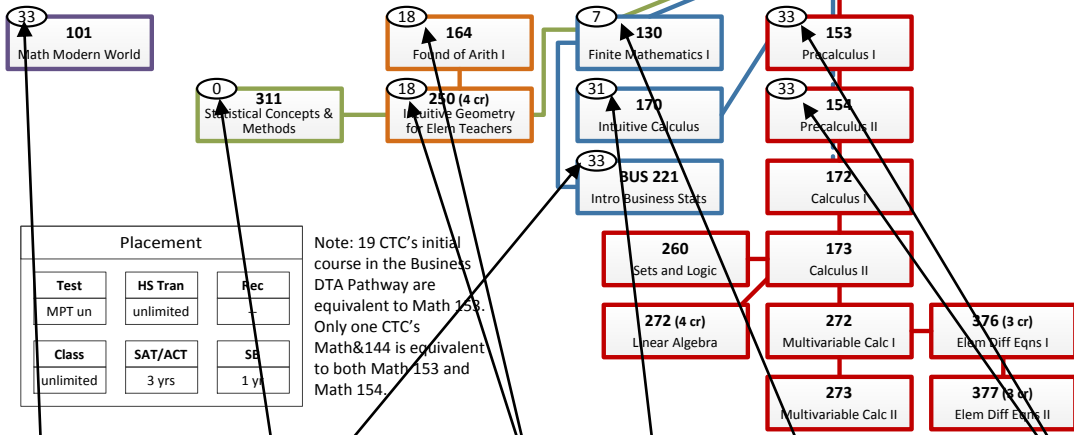
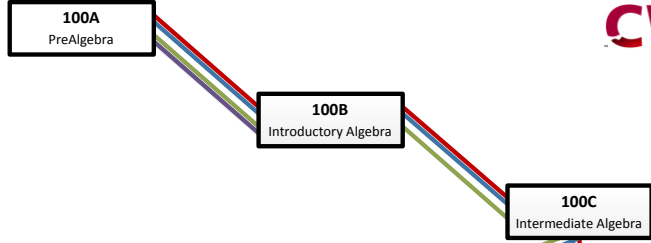

Placement		
Test	HS Tran	Rec
MPT un	unlimited	-
Class	SAT/ACT	SB
unlimited	3 yrs	1 yr

Note: 19 CTC's initial course in the Business DTA Pathway are equivalent to Math 153. Only one CTC's Math&144 is equivalent to both Math 153 and Math 154.

Number of CTCs for which Math&107 were designated as equivalent to this course at the university.

Number of CTCs for which Math&146 or Statistics course were designated as equivalent to this course at the university.

Number of CTCs for which an Elementary Education course Math&107 were designated as equivalent to this course at the university.

Number of CTCs for which a Finite Math or Business Precalculus course were designated as equivalent to this course at the university.

Number of CTCs for which Math&141 and Math&142 were designated as equivalent to these courses at the university.

Number of CTCs for which Math&148 were designated as equivalent to this course at the university.

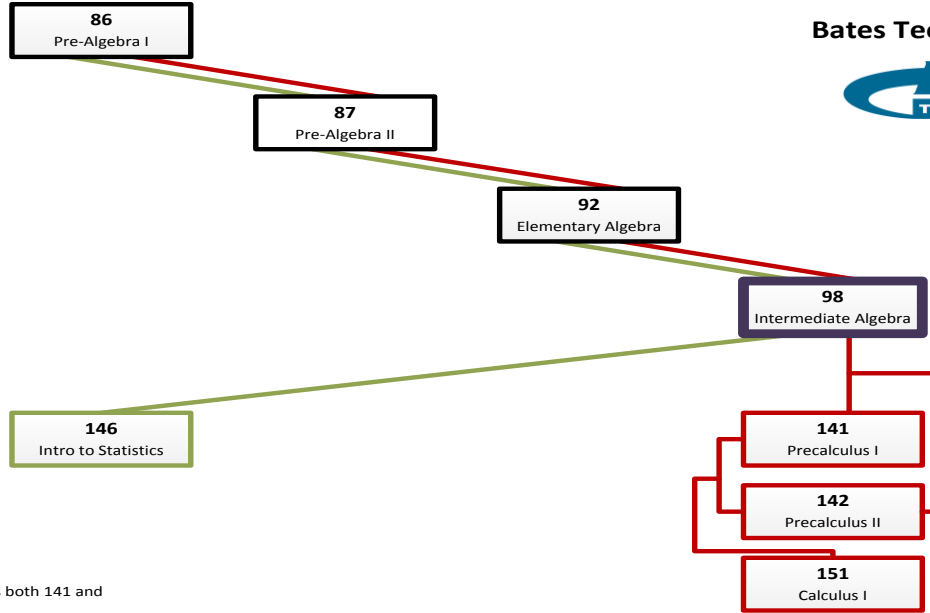

The prerequisite for 152 is both 141 and 142.

Placement		
Test	HS Tran	Rec
Acc 2yrs	1 yr	2 yrs
Class	SAT/ACT	SB
unlimited	--	1 yr

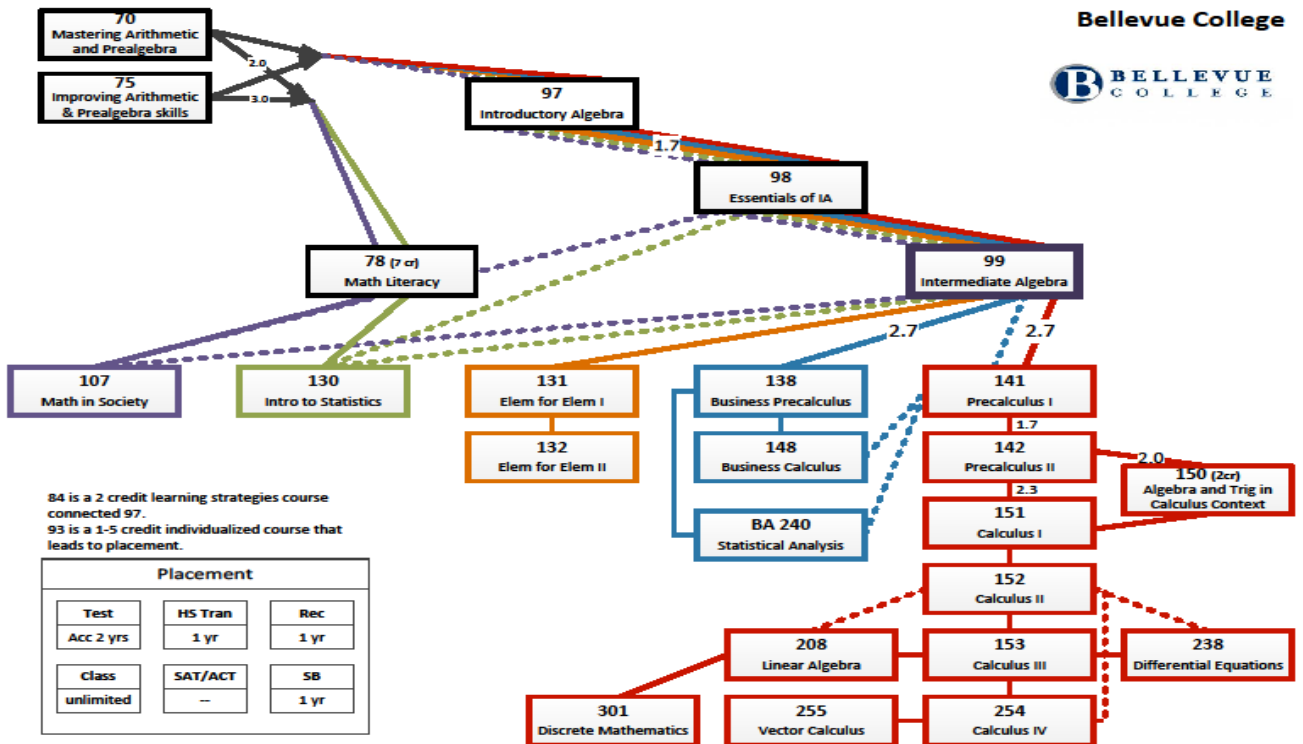

84 is a 2 credit learning strategies course connected 97.  
 93 is a 1-5 credit individualized course that leads to placement.

Placement		
Test	HS Tran	Rec
Acc 2 yrs	1 yr	1 yr
Class	SAT/ACT	SB
unlimited	--	1 yr

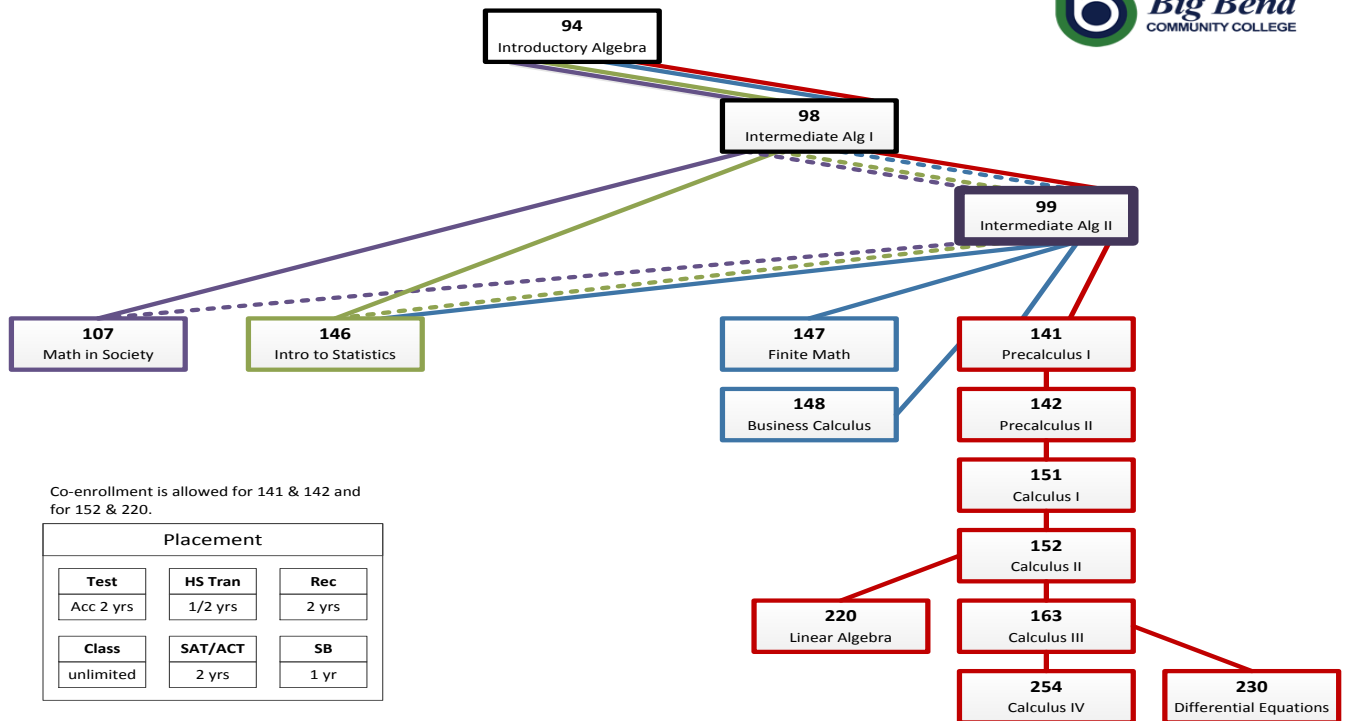
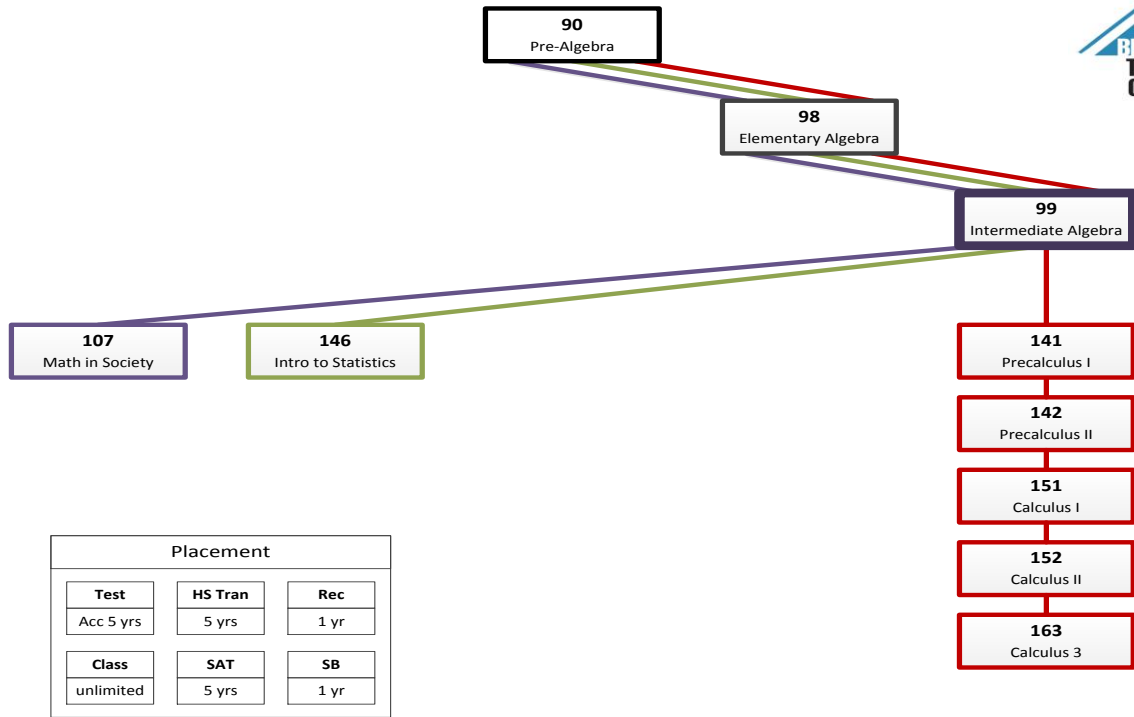

Cascadia College

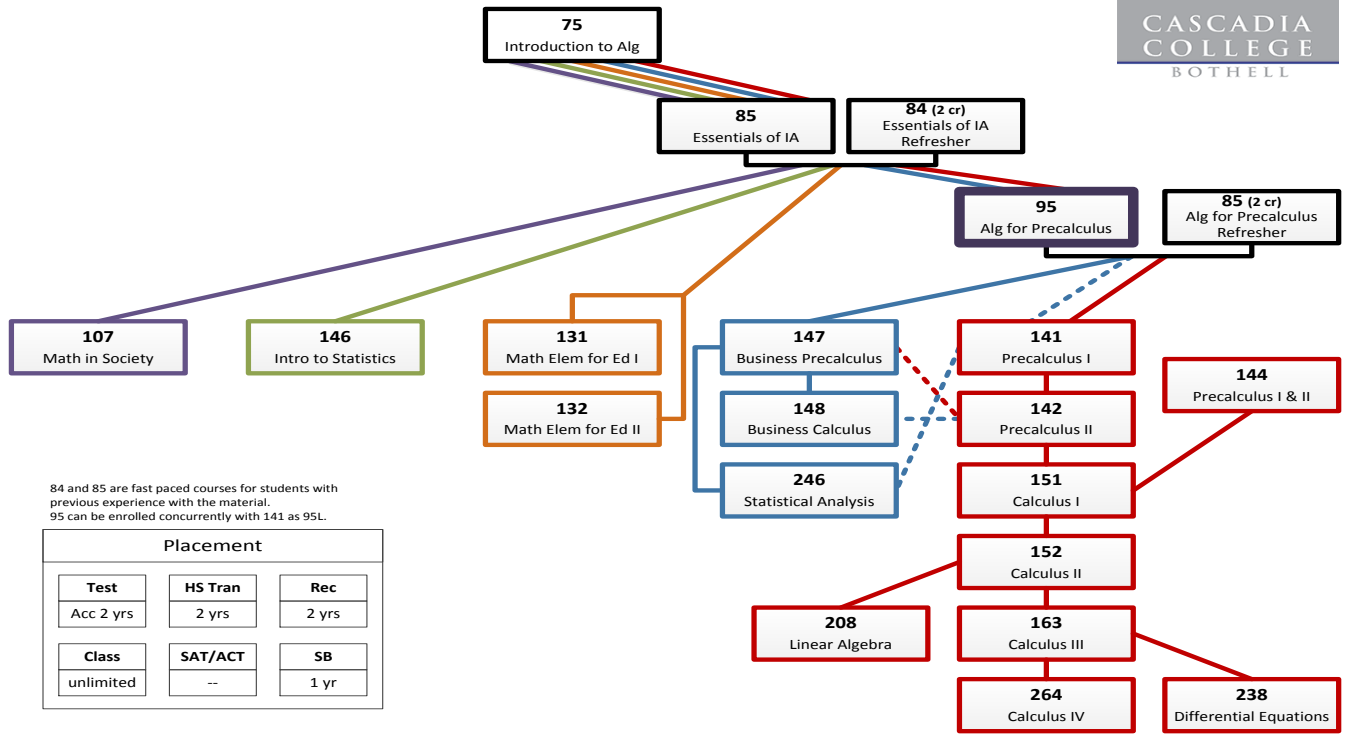

84 and 85 are fast paced courses for students with previous experience with the material.  
95 can be enrolled concurrently with 141 as 95L.

Placement		
<b>Test</b>	<b>HS Tran</b>	<b>Rec</b>
Acc 2 yrs	2 yrs	2 yrs
<b>Class</b>	<b>SAT/ACT</b>	<b>SB</b>
unlimited	--	1 yr

Centralia College

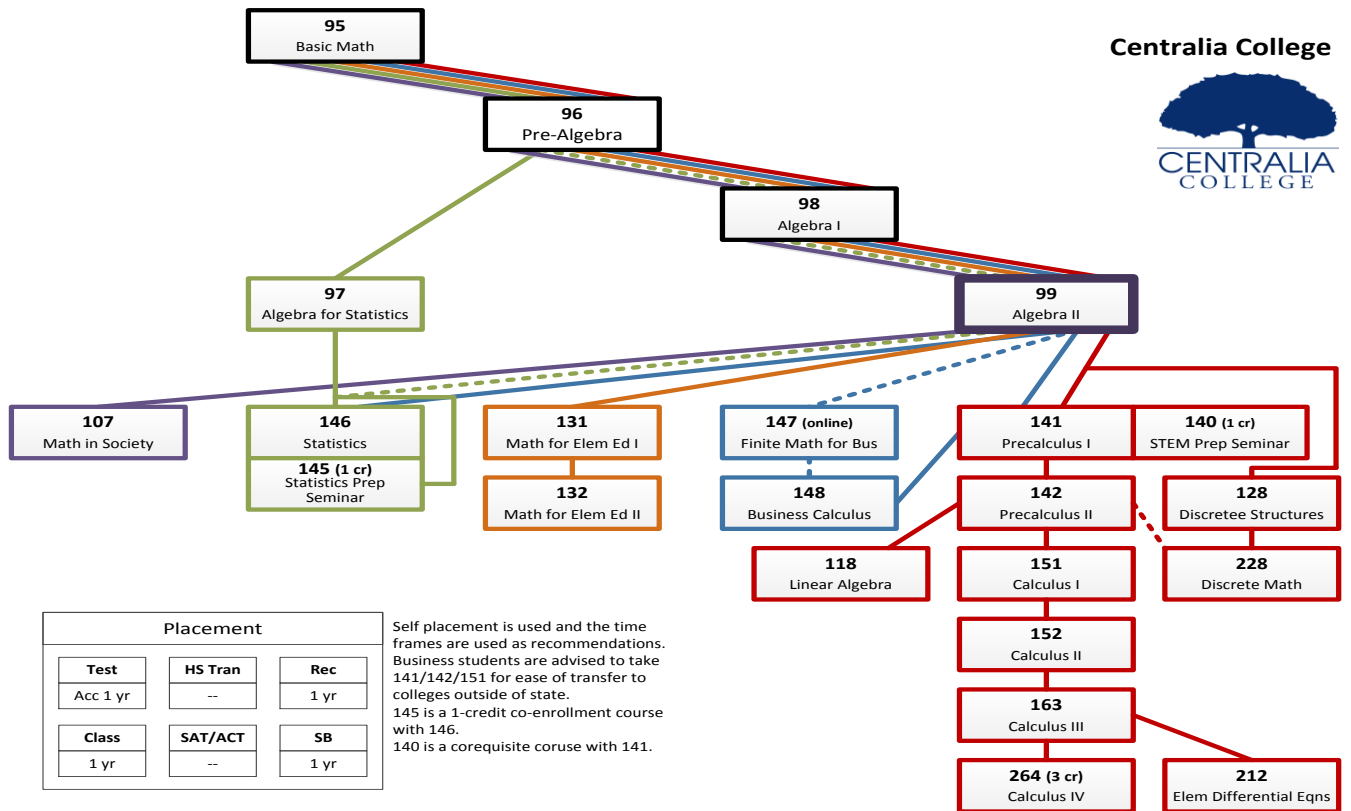

Placement		
<b>Test</b>	<b>HS Tran</b>	<b>Rec</b>
Acc 1 yr	--	1 yr
<b>Class</b>	<b>SAT/ACT</b>	<b>SB</b>
1 yr	--	1 yr

Self placement is used and the time frames are used as recommendations. Business students are advised to take 141/142/151 for ease of transfer to colleges outside of state. 145 is a 1-credit co-enrollment course with 146. 140 is a corequisite course with 141.



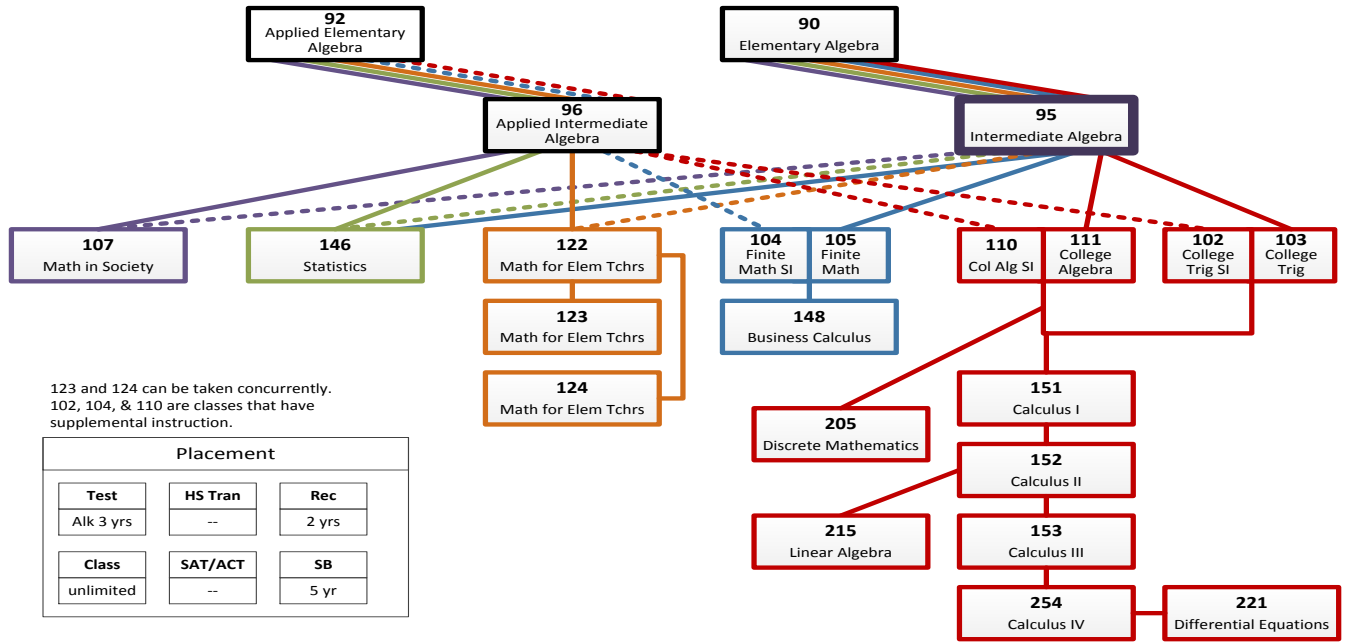

Clover Park Technical College

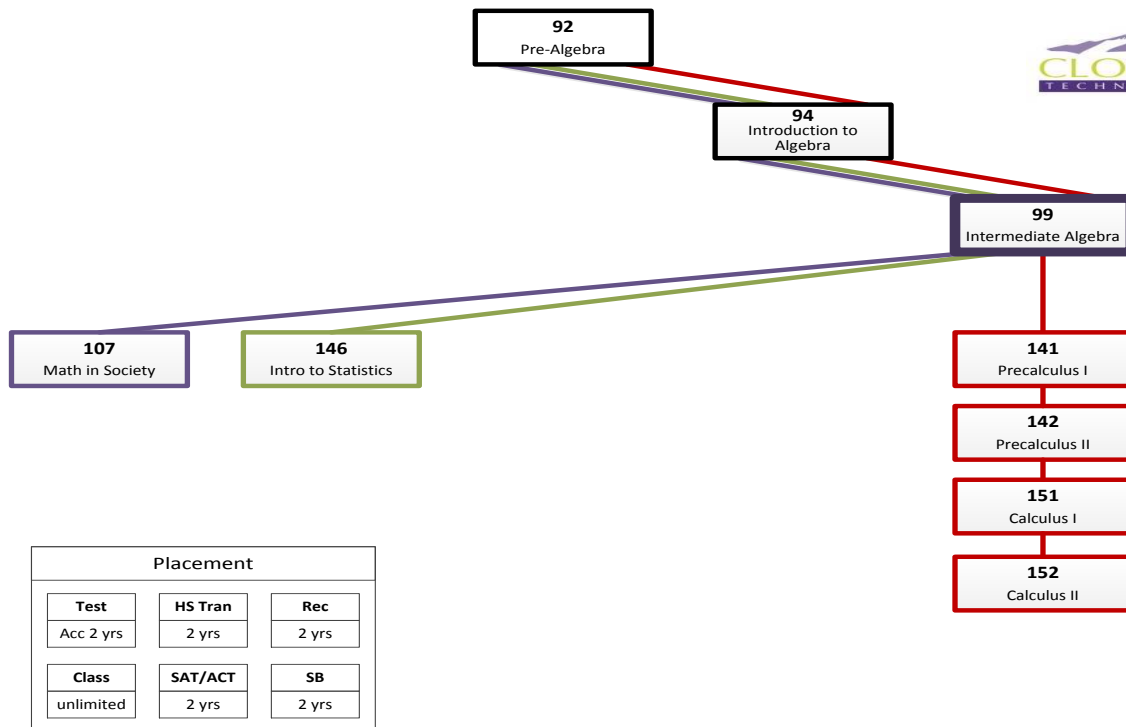

**Columbia Basin College**

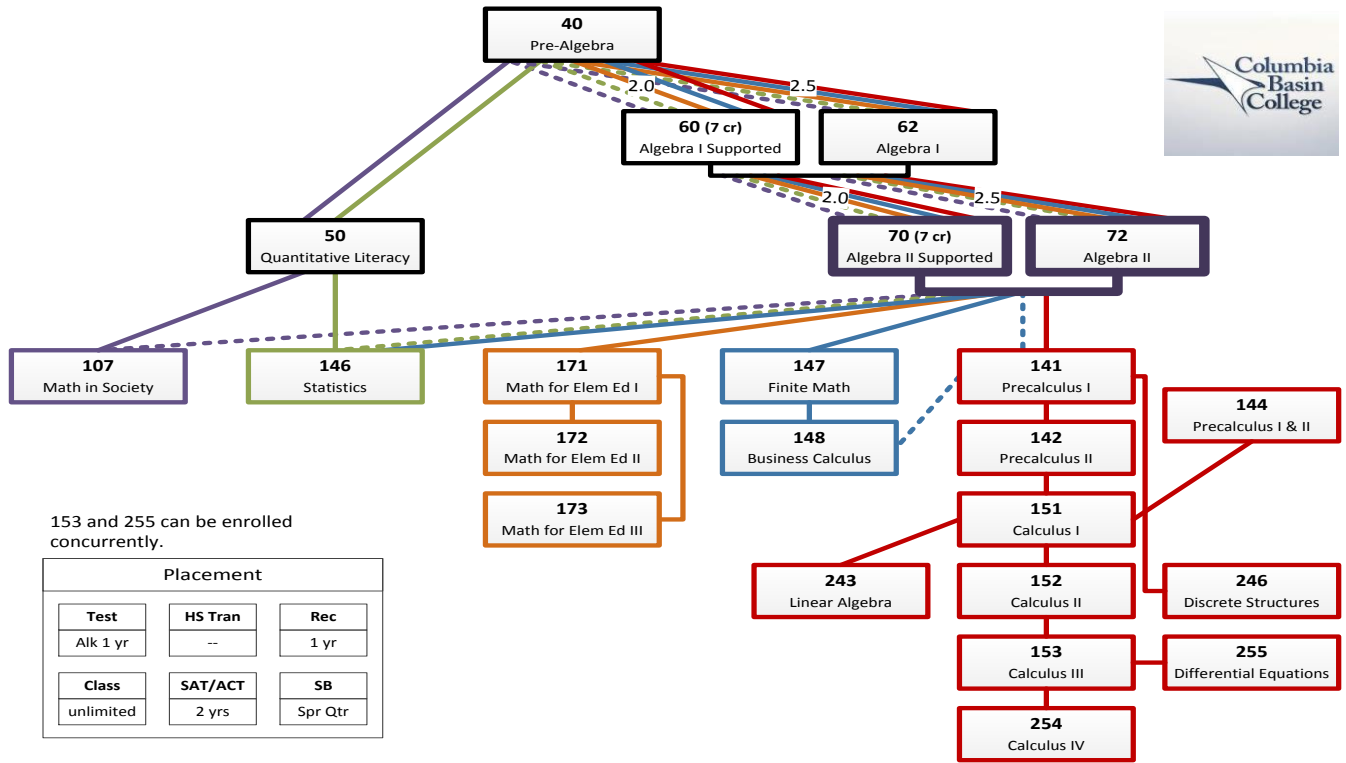

**Edmonds Community College**

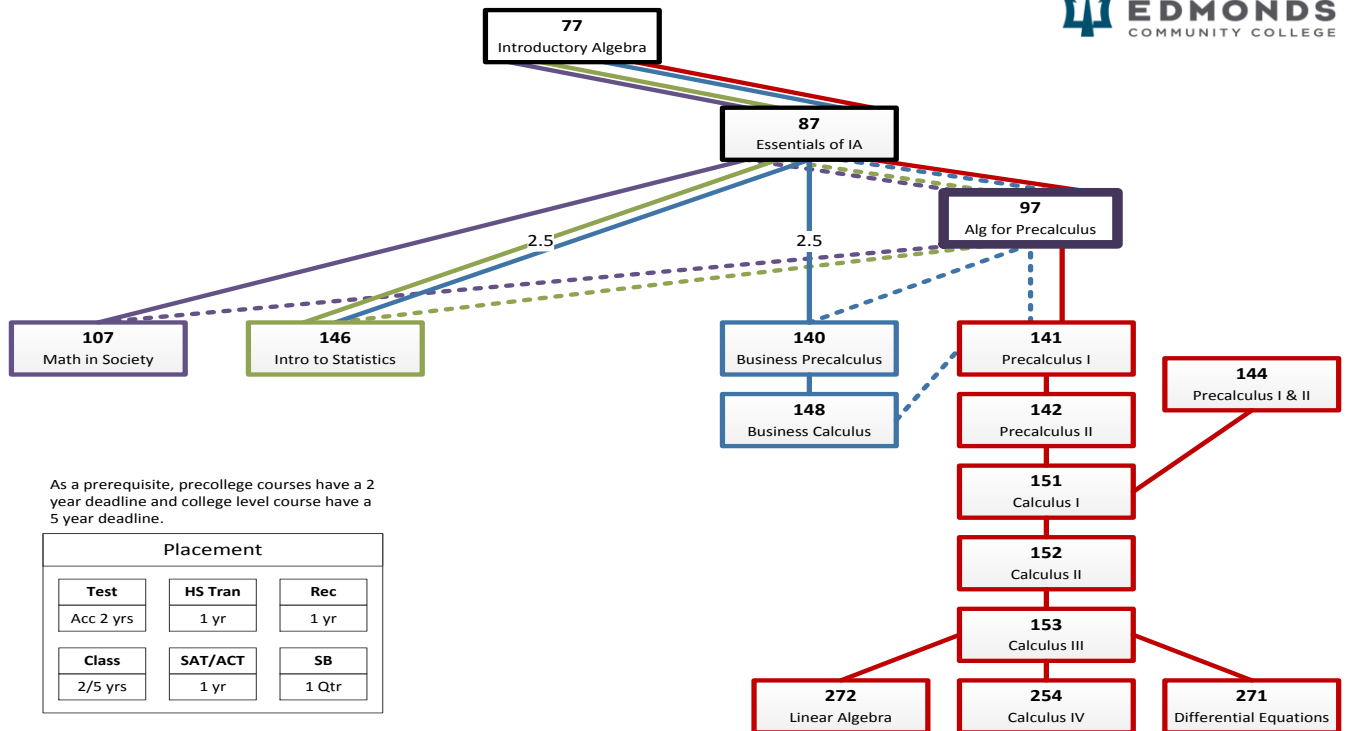

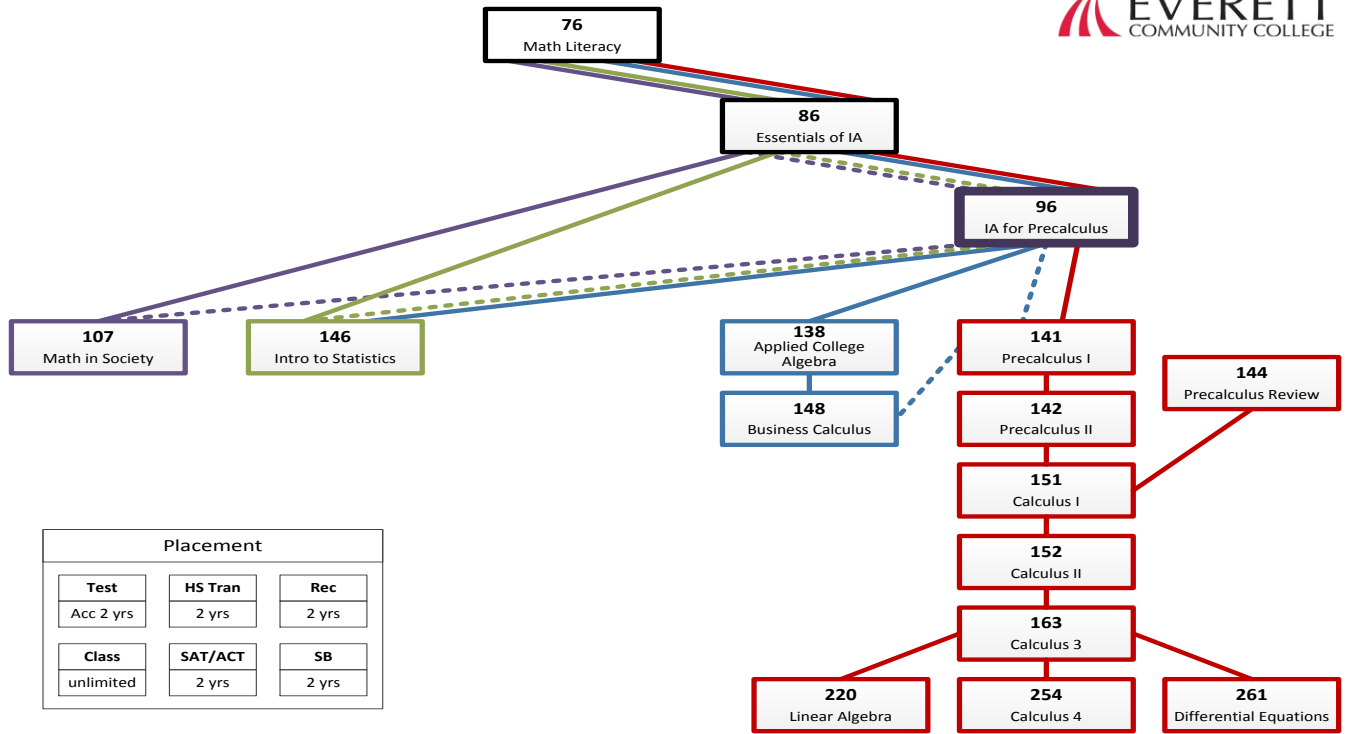

Placement		
<b>Test</b>	<b>HS Tran</b>	<b>Rec</b>
Acc 2 yrs	2 yrs	2 yrs
<b>Class</b>	<b>SAT/ACT</b>	<b>SB</b>
unlimited	2 yrs	2 yrs

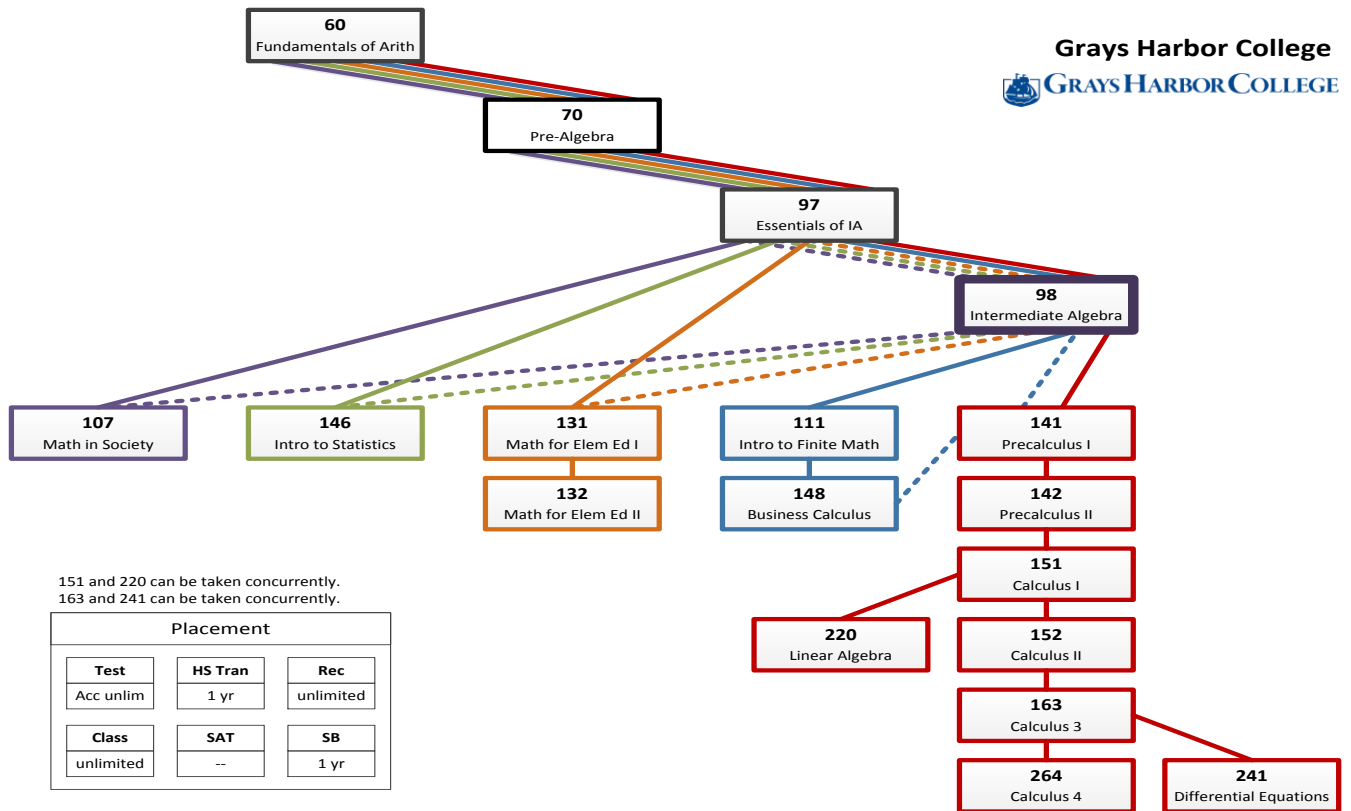

151 and 220 can be taken concurrently.  
163 and 241 can be taken concurrently.

Placement		
<b>Test</b>	<b>HS Tran</b>	<b>Rec</b>
Acc unlim	1 yr	unlimited
<b>Class</b>	<b>SAT</b>	<b>SB</b>
unlimited	--	1 yr

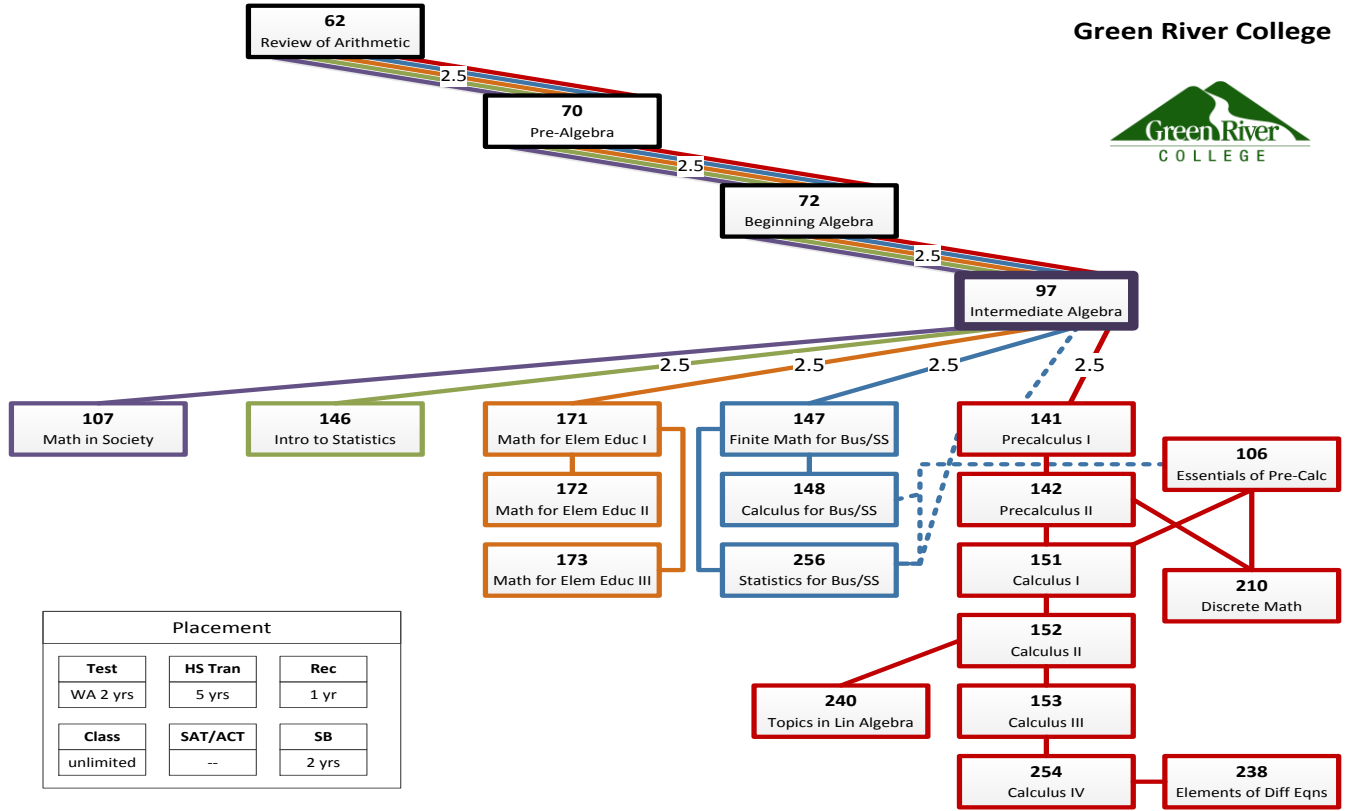

Placement		
<b>Test</b>	<b>HS Tran</b>	<b>Rec</b>
WA 2 yrs	5 yrs	1 yr
<b>Class</b>	<b>SAT/ACT</b>	<b>SB</b>
unlimited	--	2 yrs

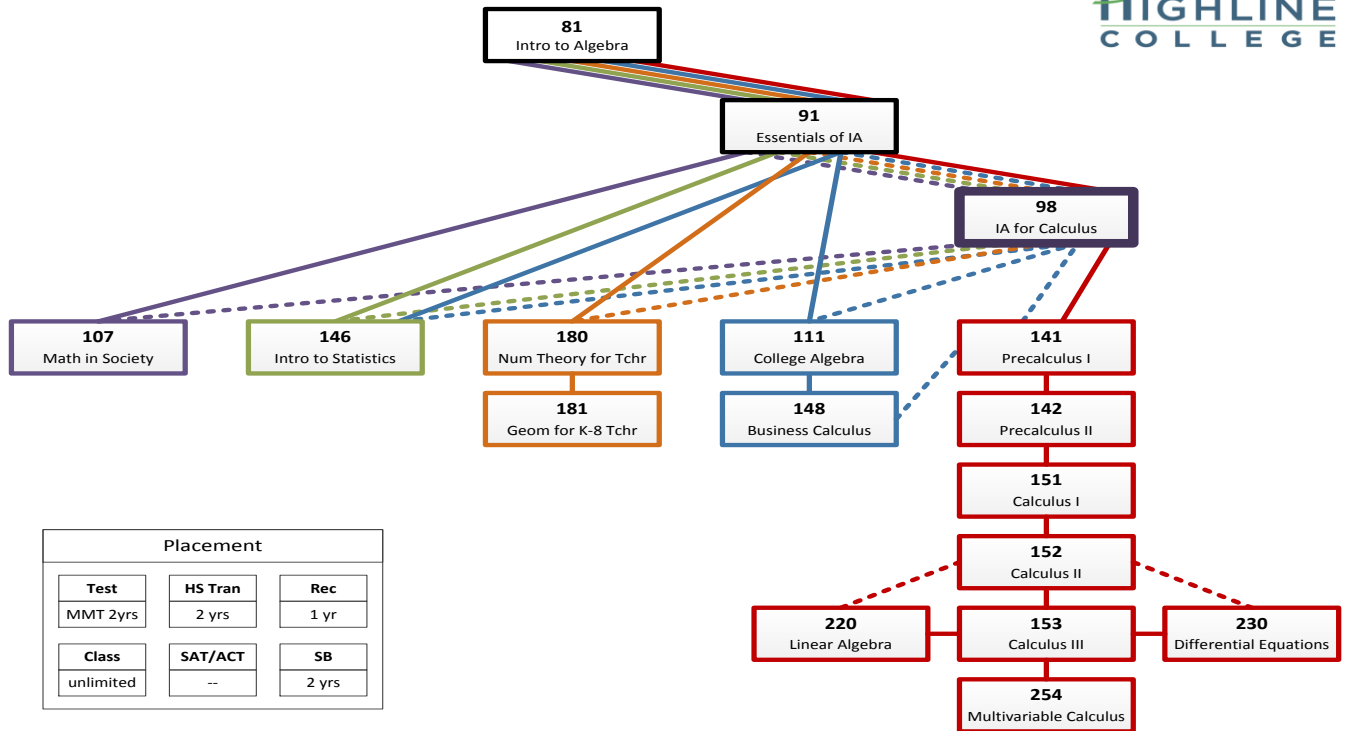

Placement		
<b>Test</b>	<b>HS Tran</b>	<b>Rec</b>
MMT 2yrs	2 yrs	1 yr
<b>Class</b>	<b>SAT/ACT</b>	<b>SB</b>
unlimited	--	2 yrs

# Lake Washington Institute of Technology

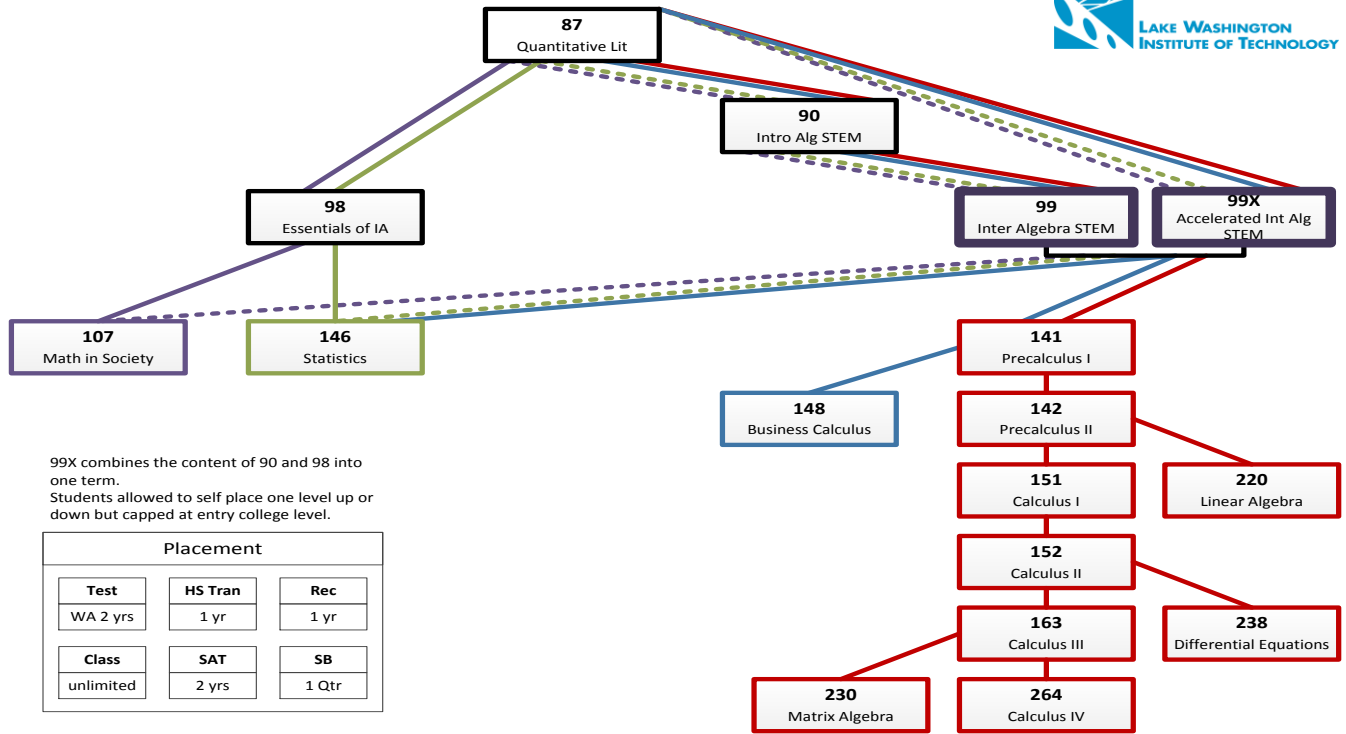

99X combines the content of 90 and 98 into one term. Students allowed to self place one level up or down but capped at entry college level.

Placement		
<b>Test</b>	<b>HS Tran</b>	<b>Rec</b>
WA 2 yrs	1 yr	1 yr
<b>Class</b>	<b>SAT</b>	<b>SB</b>
unlimited	2 yrs	1 Qtr

# Lower Columbia College

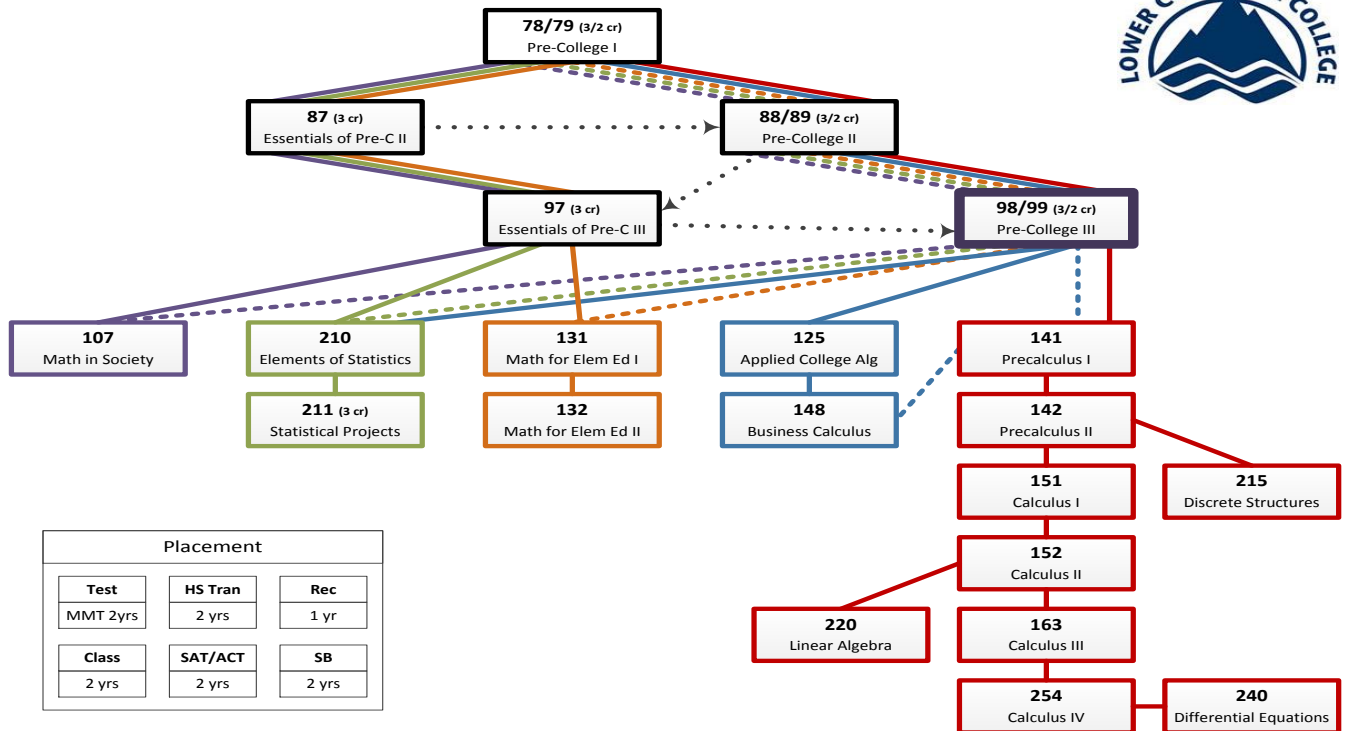

Placement		
<b>Test</b>	<b>HS Tran</b>	<b>Rec</b>
MMT 2yrs	2 yrs	1 yr
<b>Class</b>	<b>SAT/ACT</b>	<b>SB</b>
2 yrs	2 yrs	2 yrs

# North Seattle College

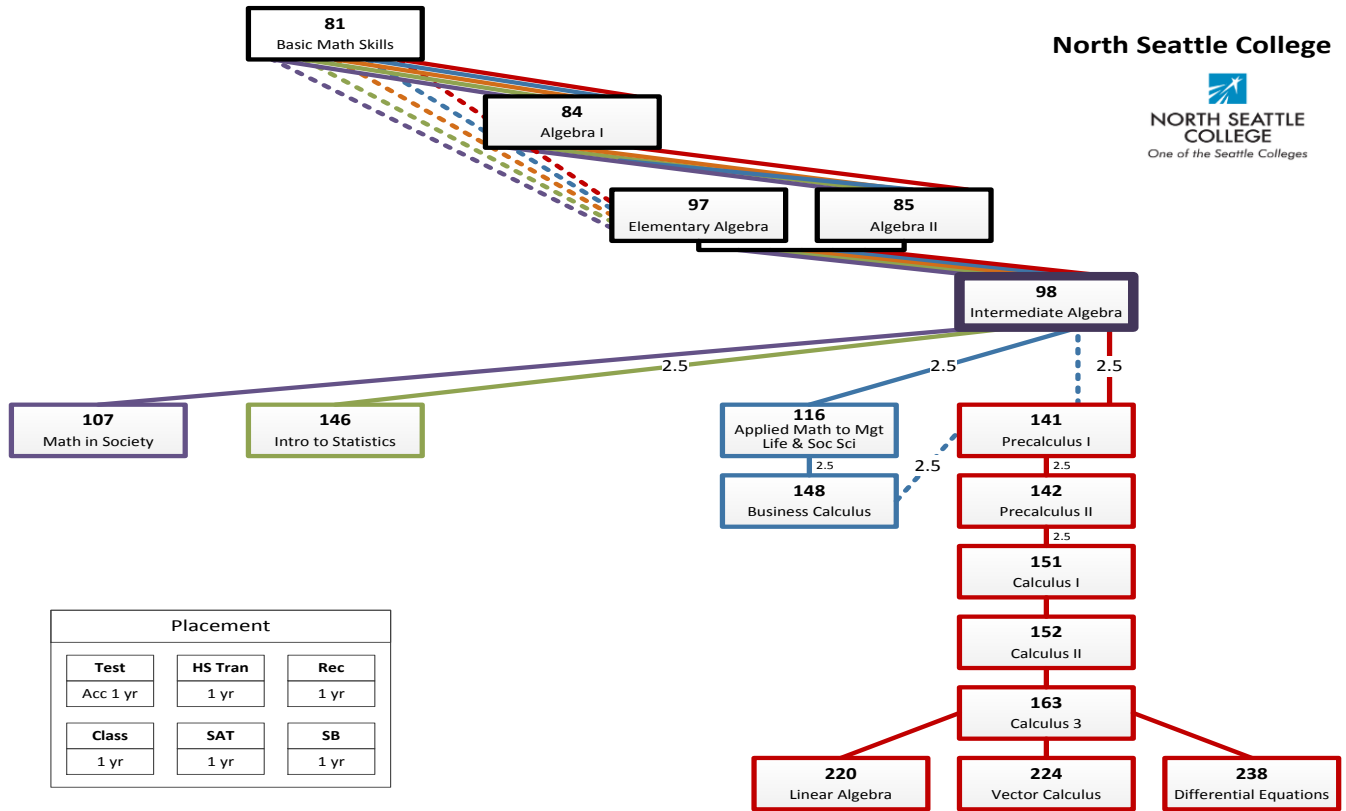

Placement		
<b>Test</b>	<b>HS Tran</b>	<b>Rec</b>
Acc 1 yr	1 yr	1 yr
<b>Class</b>	<b>SAT</b>	<b>SB</b>
1 yr	1 yr	1 yr

# Olympic College

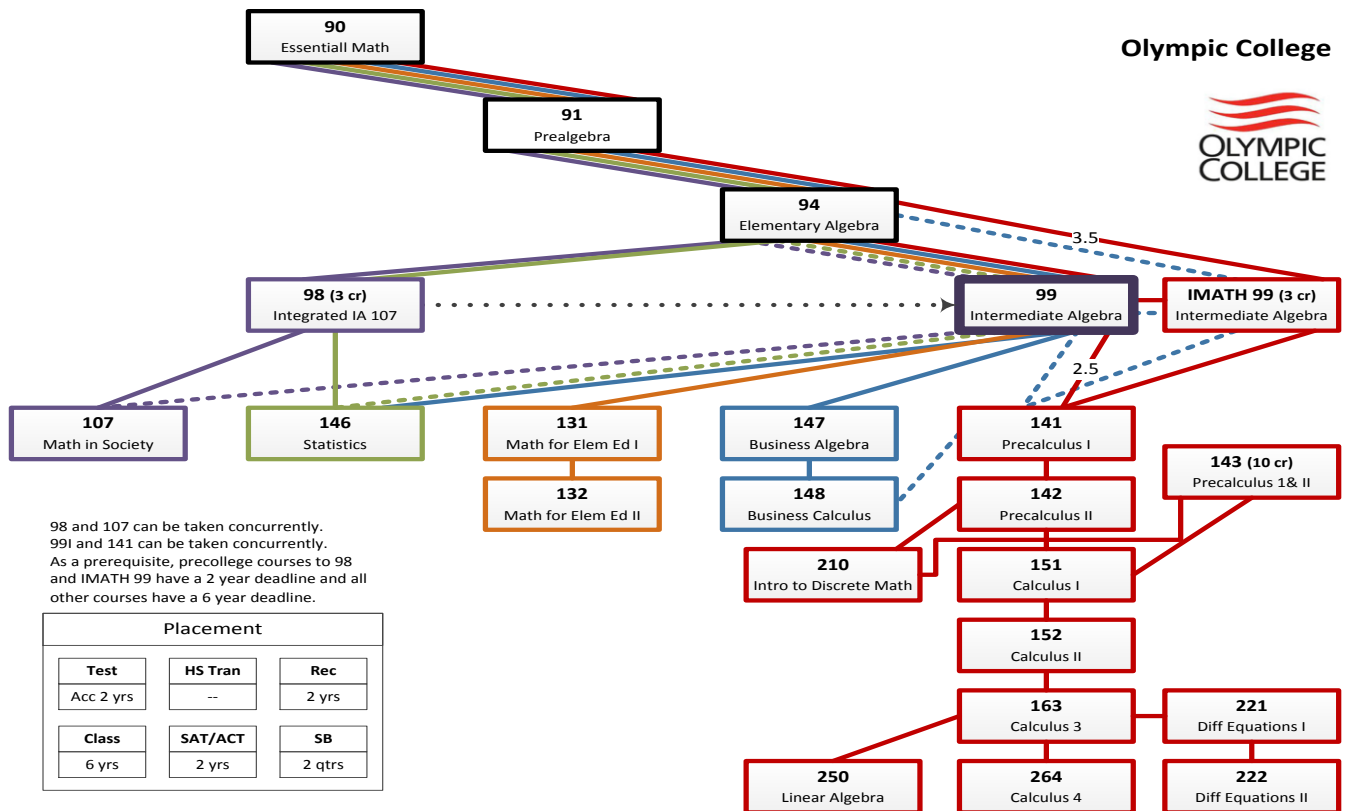

98 and 107 can be taken concurrently.  
 99I and 141 can be taken concurrently.  
 As a prerequisite, precollege courses to 98 and IMATH 99 have a 2 year deadline and all other courses have a 6 year deadline.

Placement		
<b>Test</b>	<b>HS Tran</b>	<b>Rec</b>
Acc 2 yrs	--	2 yrs
<b>Class</b>	<b>SAT/ACT</b>	<b>SB</b>
6 yrs	2 yrs	2 qtrs

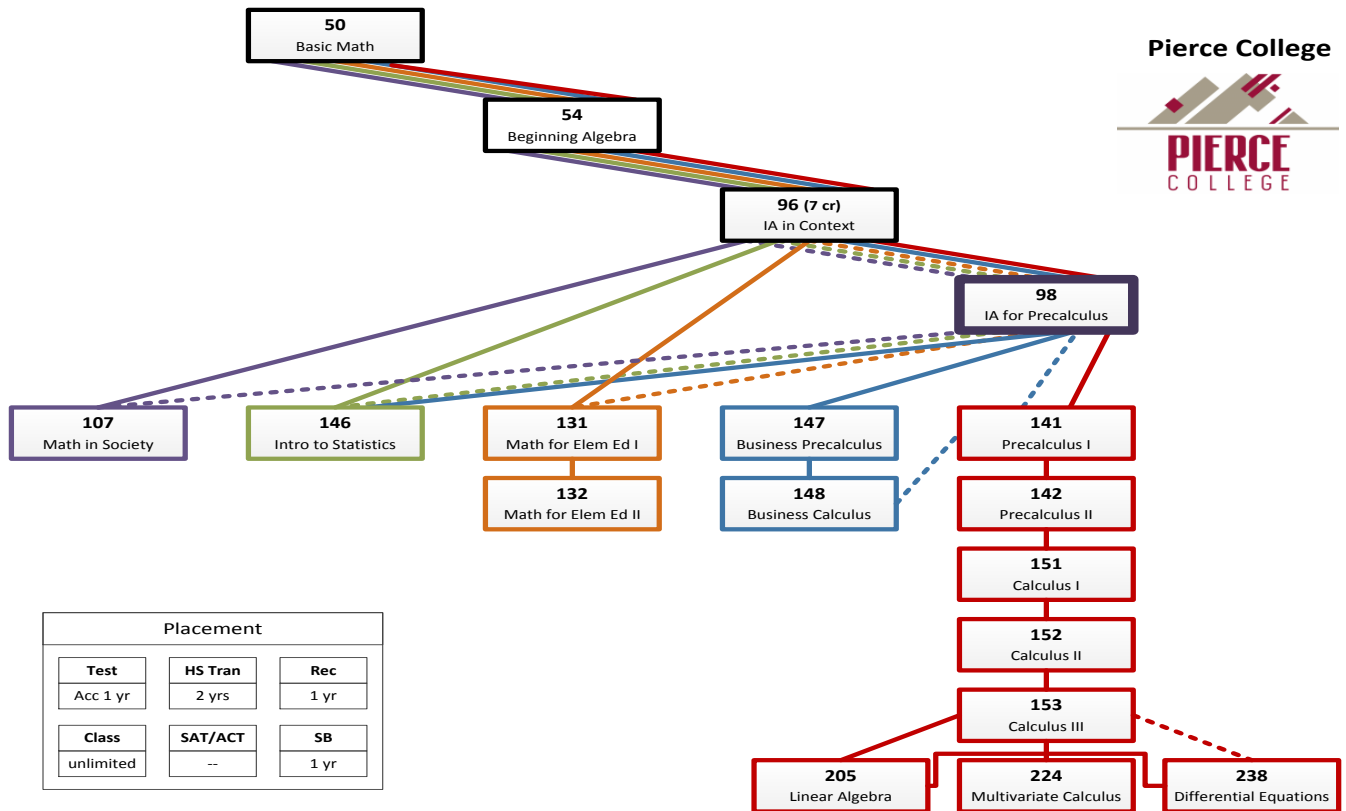
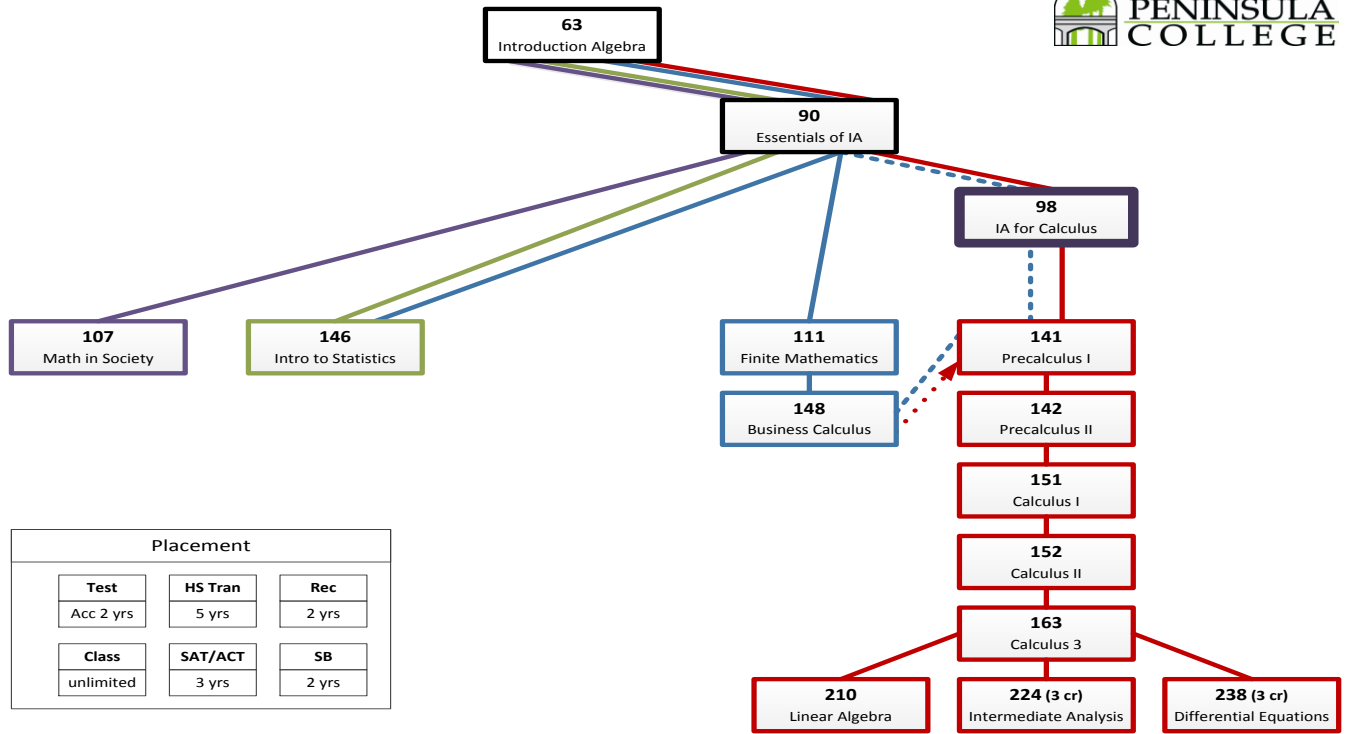

## Renton Technical College

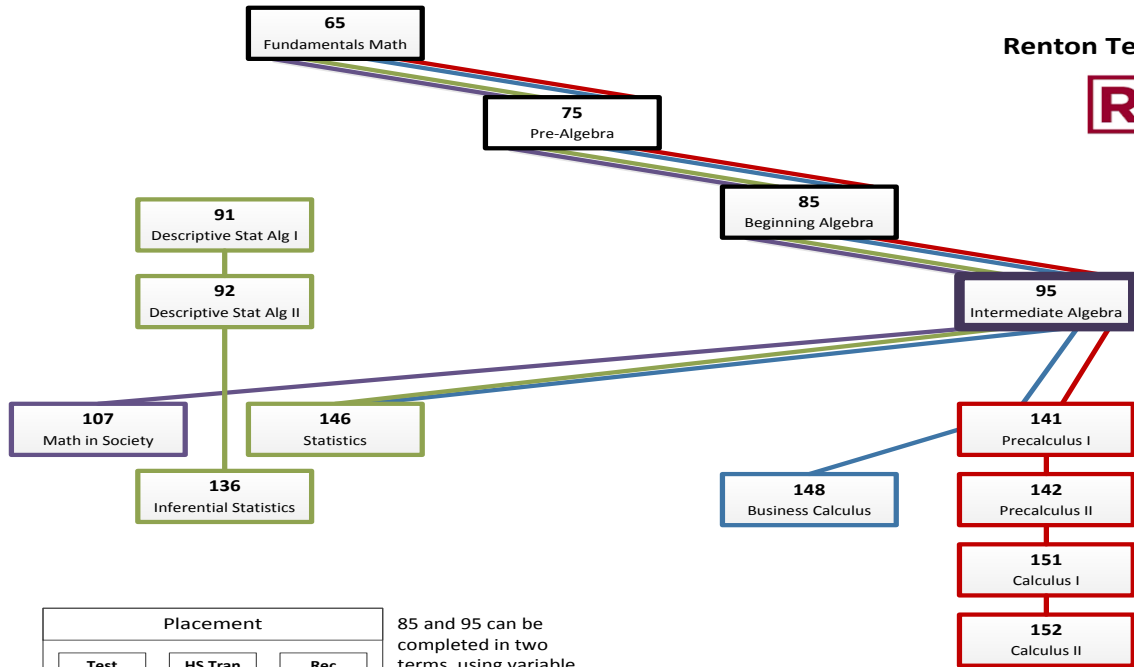

Placement		
Test	HS Tran	Rec
Acc 1 yr	1 yr	1 yr
Class	SAT/ACT	SB
unlimited	--	1 yr

85 and 95 can be completed in two terms, using variable credit. Accuplacer is used for college level and directed self placement for precollege.

## Seattle Central College

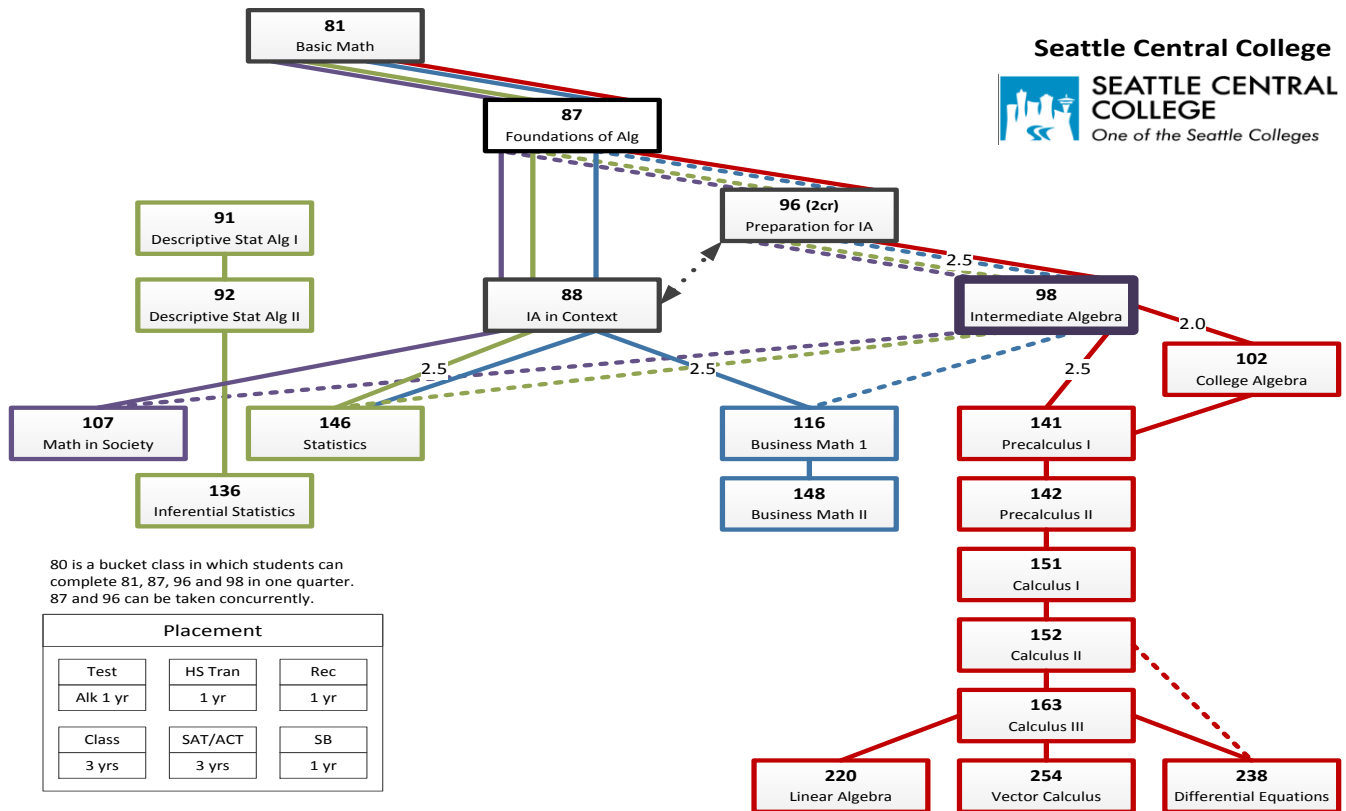

80 is a bucket class in which students can complete 81, 87, 96 and 98 in one quarter. 87 and 96 can be taken concurrently.

Placement		
Test	HS Tran	Rec
Alk 1 yr	1 yr	1 yr
Class	SAT/ACT	SB
3 yrs	3 yrs	1 yr



## Shoreline Community College

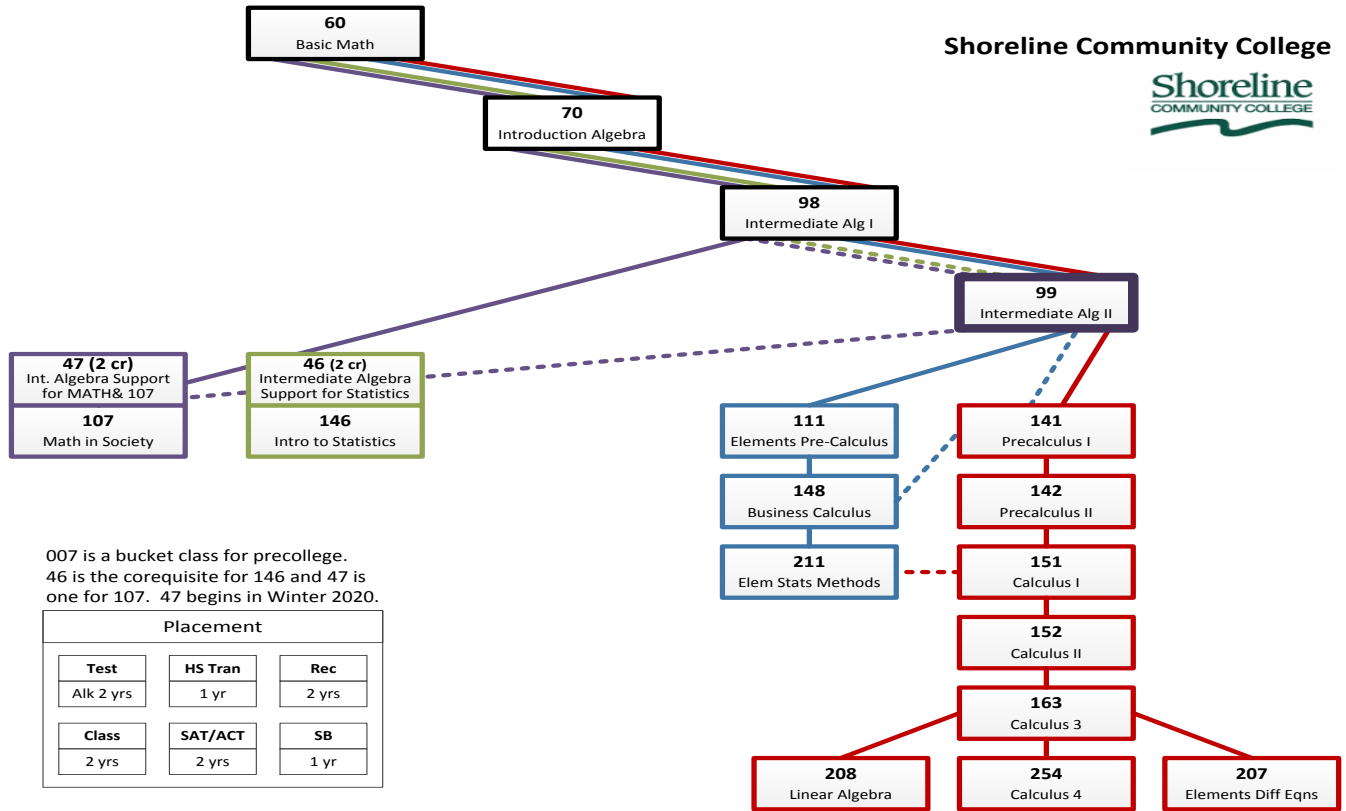

## Skagit Valley College

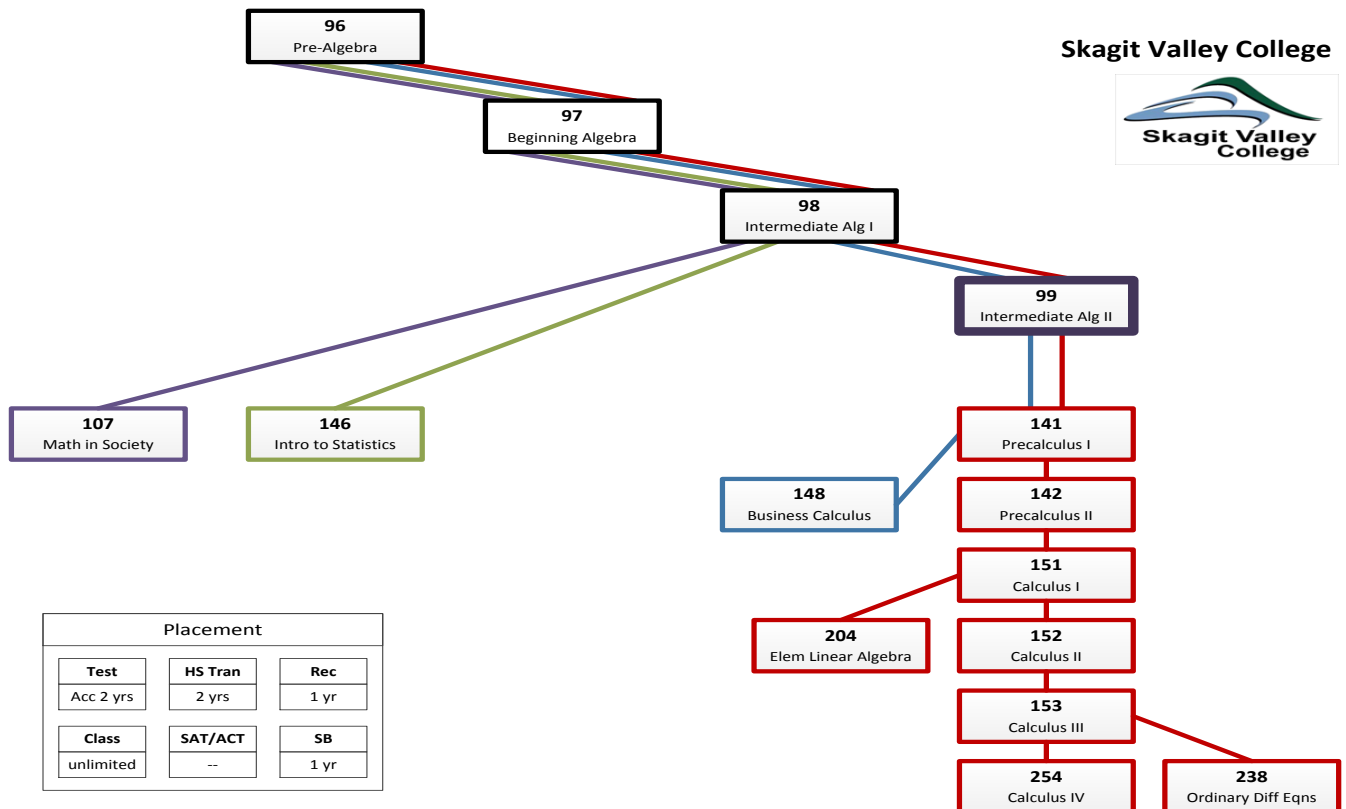

South Puget Sound Community College

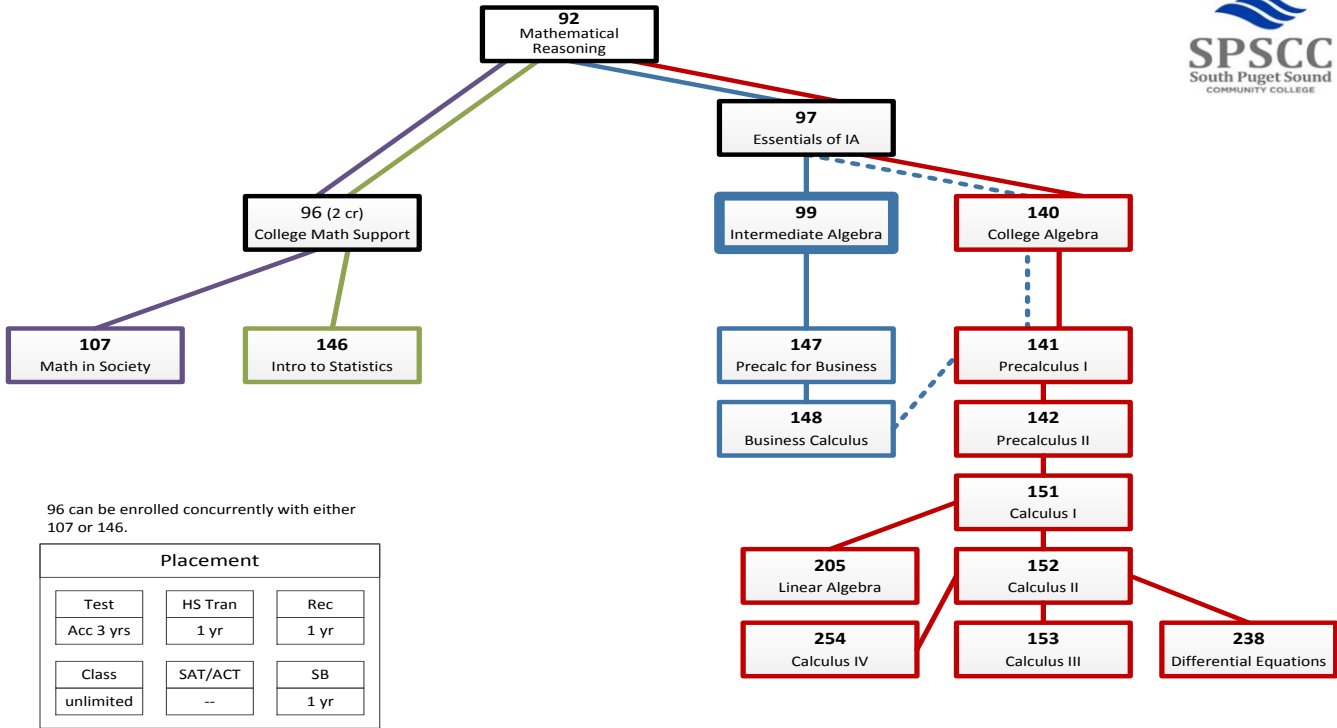

96 can be enrolled concurrently with either 107 or 146.

Placement		
Test	HS Tran	Rec
Acc 3 yrs	1 yr	1 yr
Class	SAT/ACT	SB
unlimited	--	1 yr

South Seattle College



SOUTH SEATTLE COLLEGE  
One of the Seattle Colleges

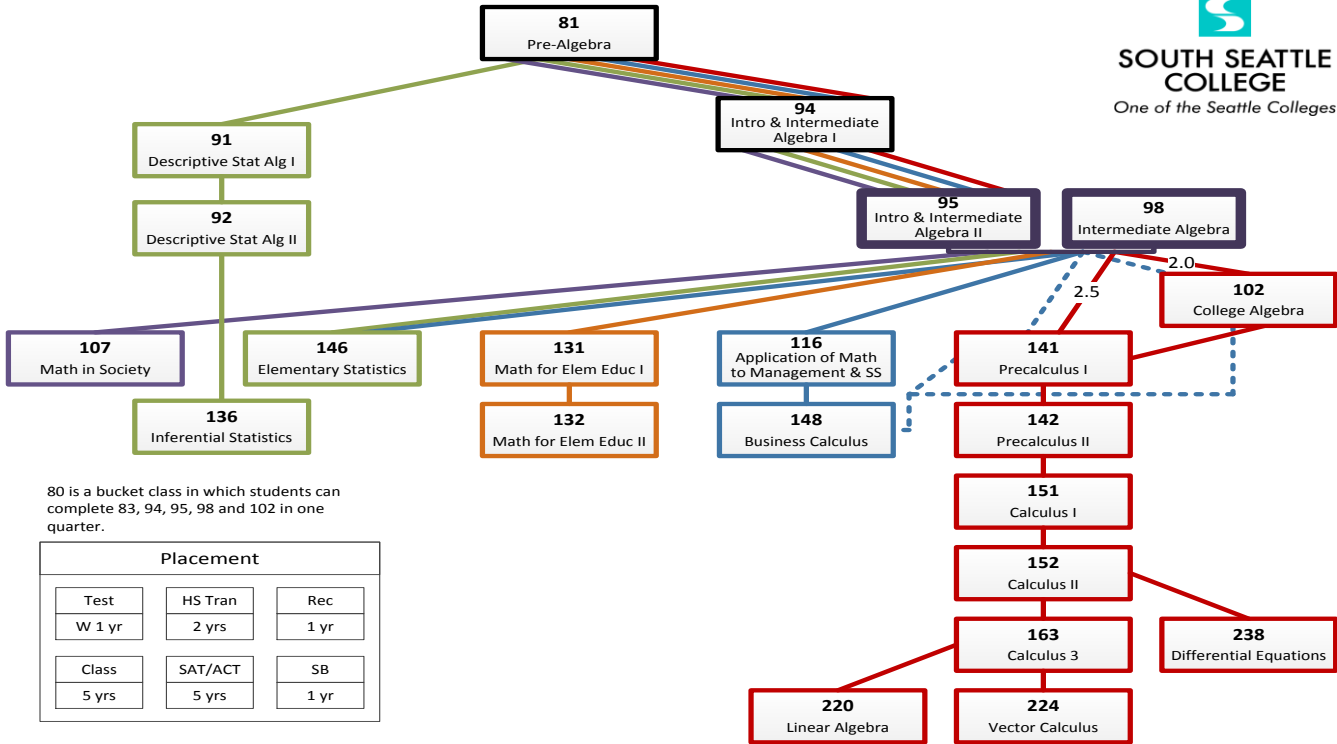

80 is a bucket class in which students can complete 83, 94, 95, 98 and 102 in one quarter.

Placement		
Test	HS Tran	Rec
W 1 yr	2 yrs	1 yr
Class	SAT/ACT	SB
5 yrs	5 yrs	1 yr

## Spokane Community College

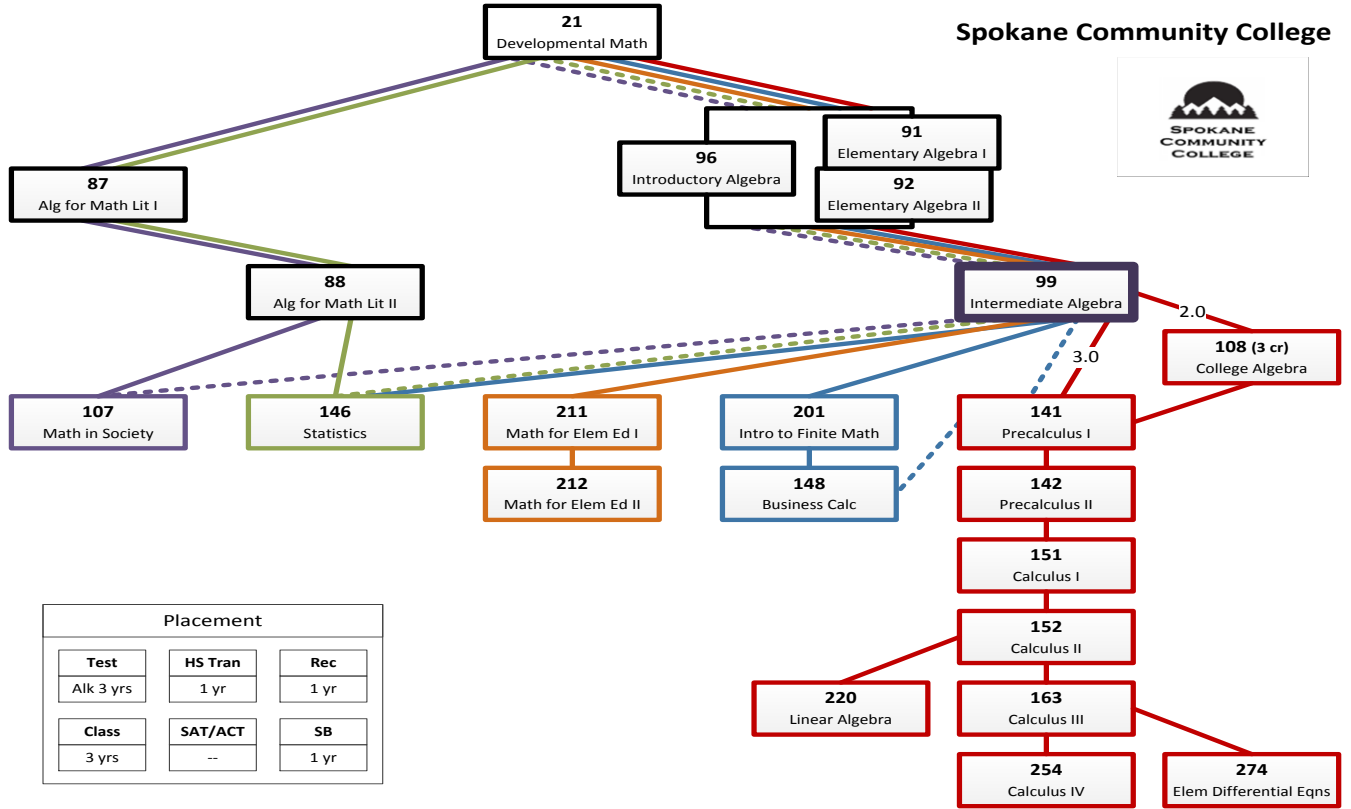

Placement		
<b>Test</b>	<b>HS Tran</b>	<b>Rec</b>
Alk 3 yrs	1 yr	1 yr
<b>Class</b>	<b>SAT/ACT</b>	<b>SB</b>
3 yrs	--	1 yr

## Spokane Falls Community College

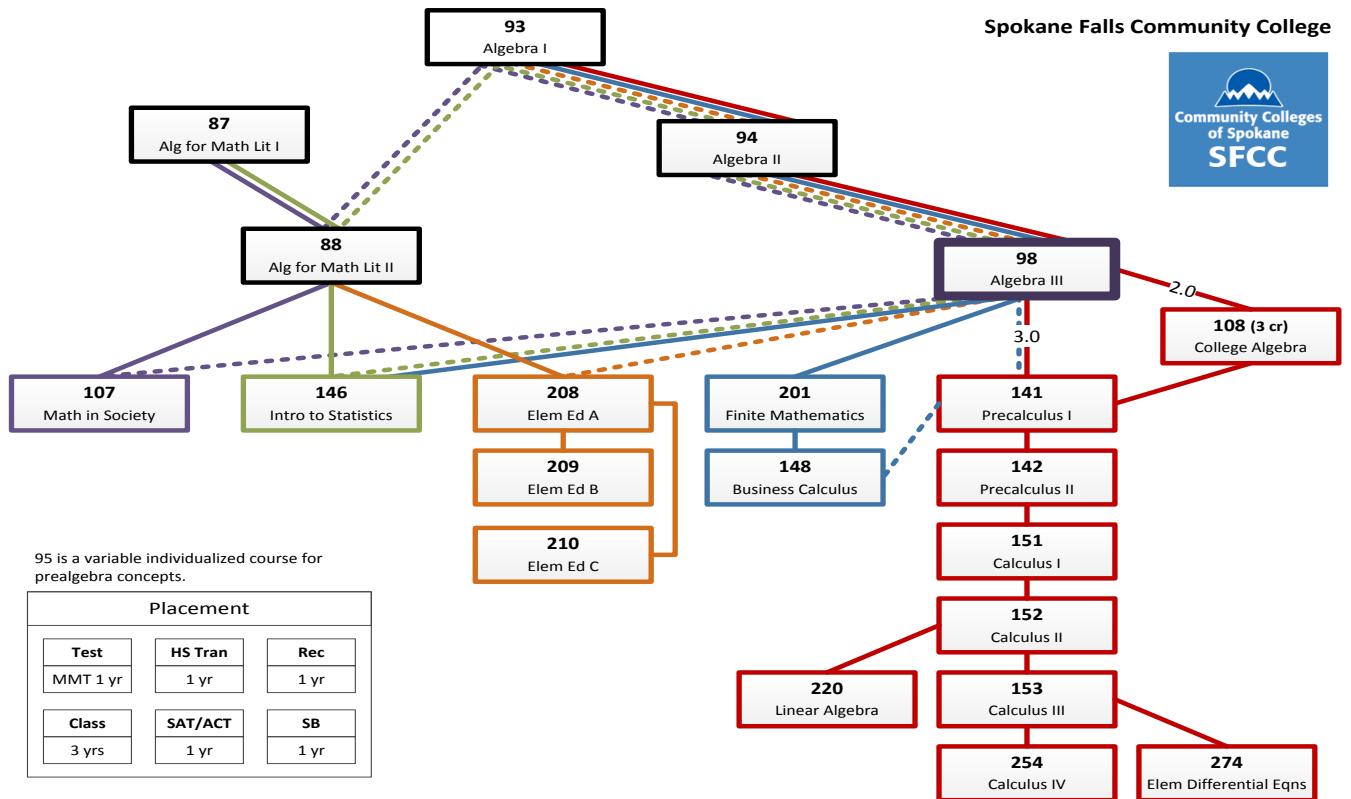

95 is a variable individualized course for prealgebra concepts.

Placement		
<b>Test</b>	<b>HS Tran</b>	<b>Rec</b>
MMT 1 yr	1 yr	1 yr
<b>Class</b>	<b>SAT/ACT</b>	<b>SB</b>
3 yrs	1 yr	1 yr

## Tacoma Community College

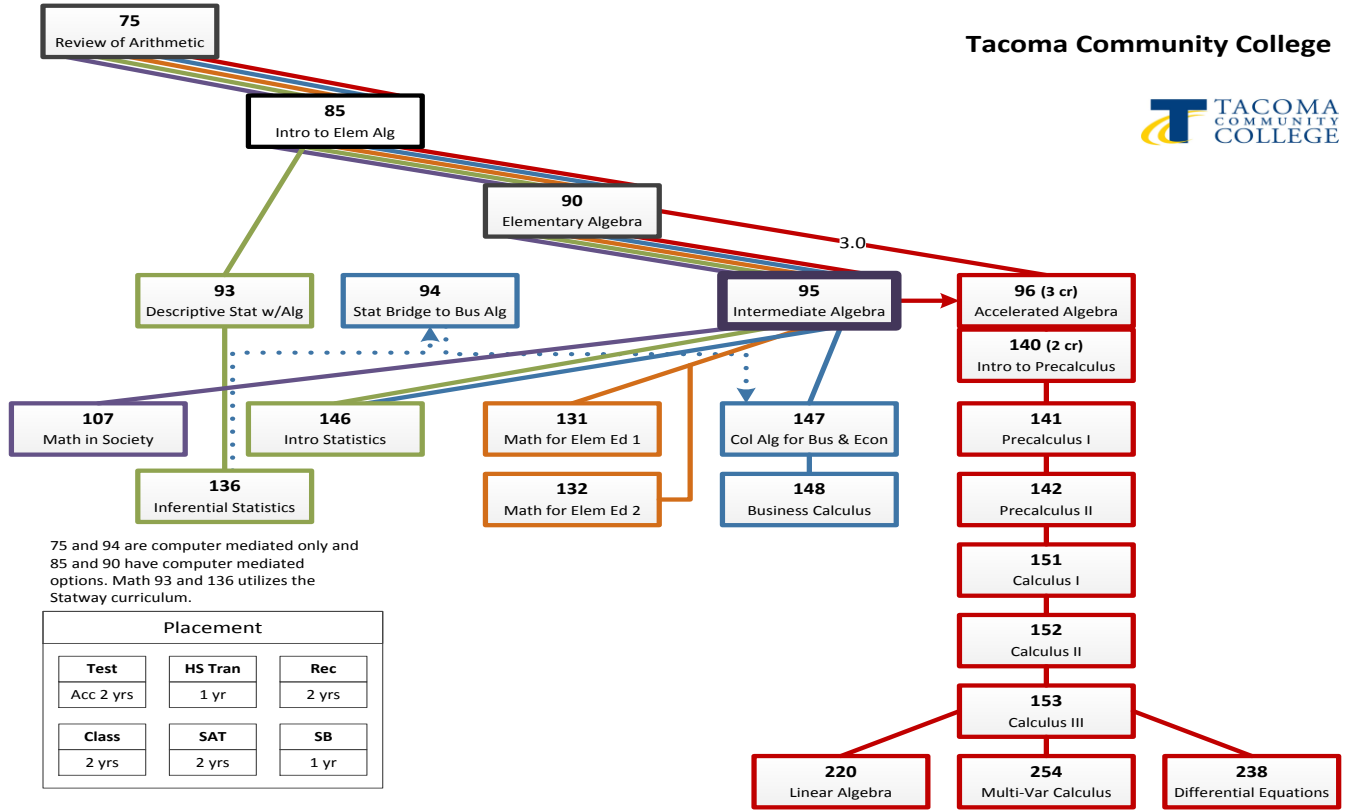

## Walla Walla Community College

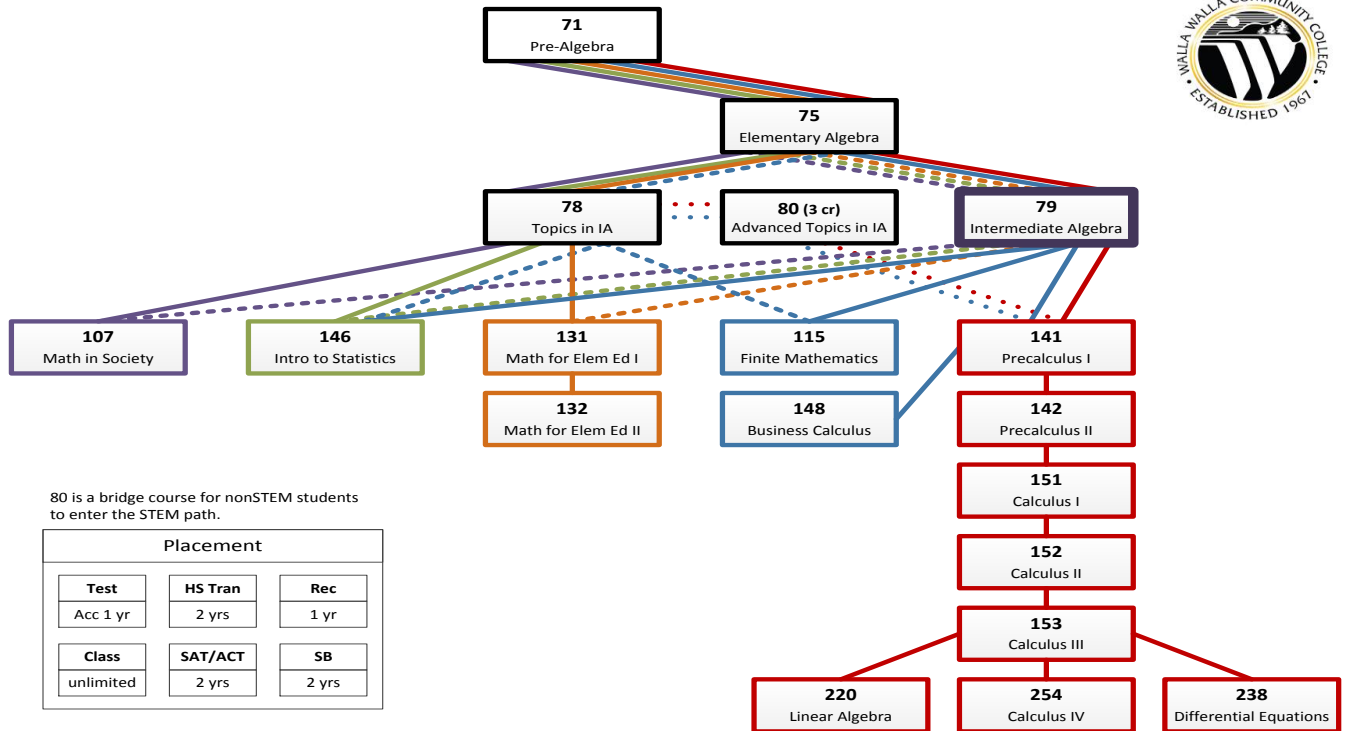

## Wenatchee Valley College

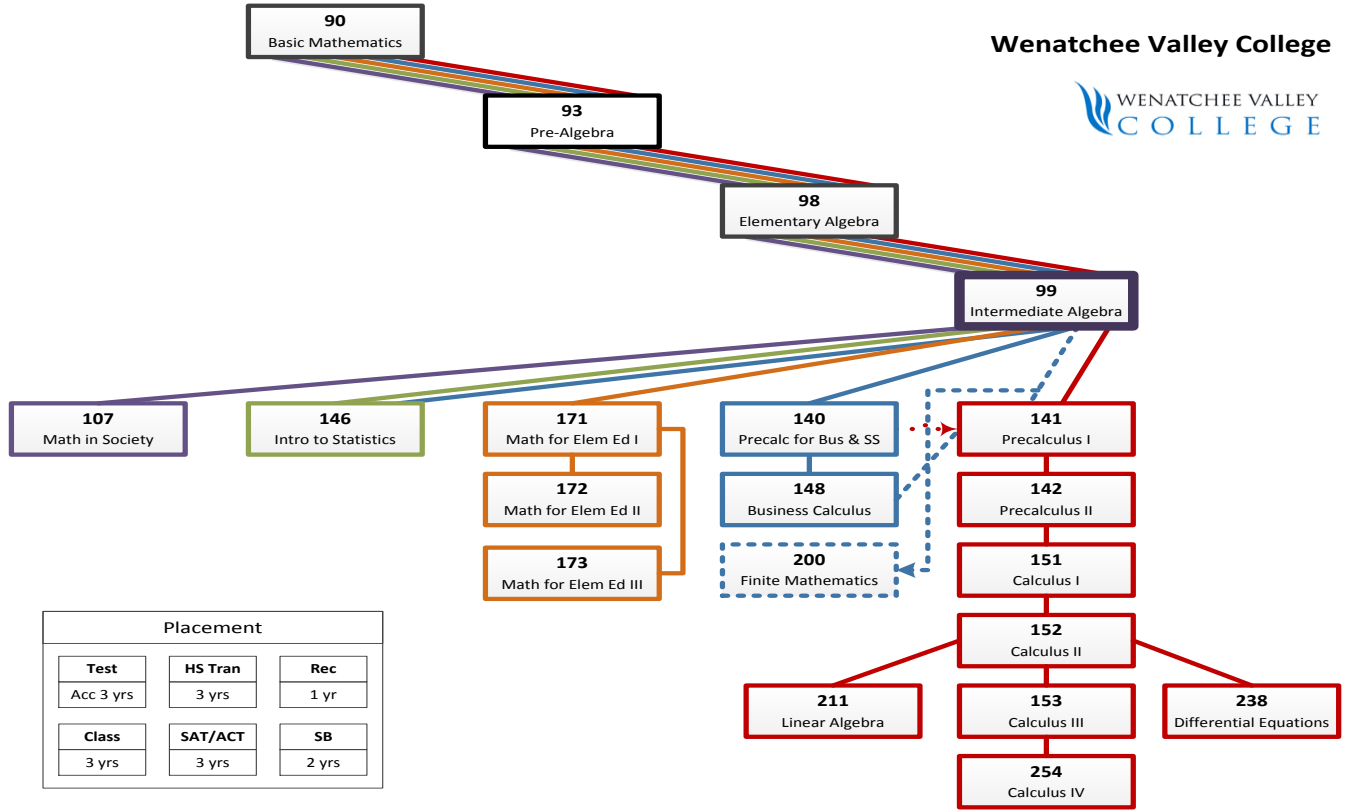

Placement		
<b>Test</b>	<b>HS Tran</b>	<b>Rec</b>
Acc 3 yrs	3 yrs	1 yr
<b>Class</b>	<b>SAT/ACT</b>	<b>SB</b>
3 yrs	3 yrs	2 yrs

## Whatcom Community College

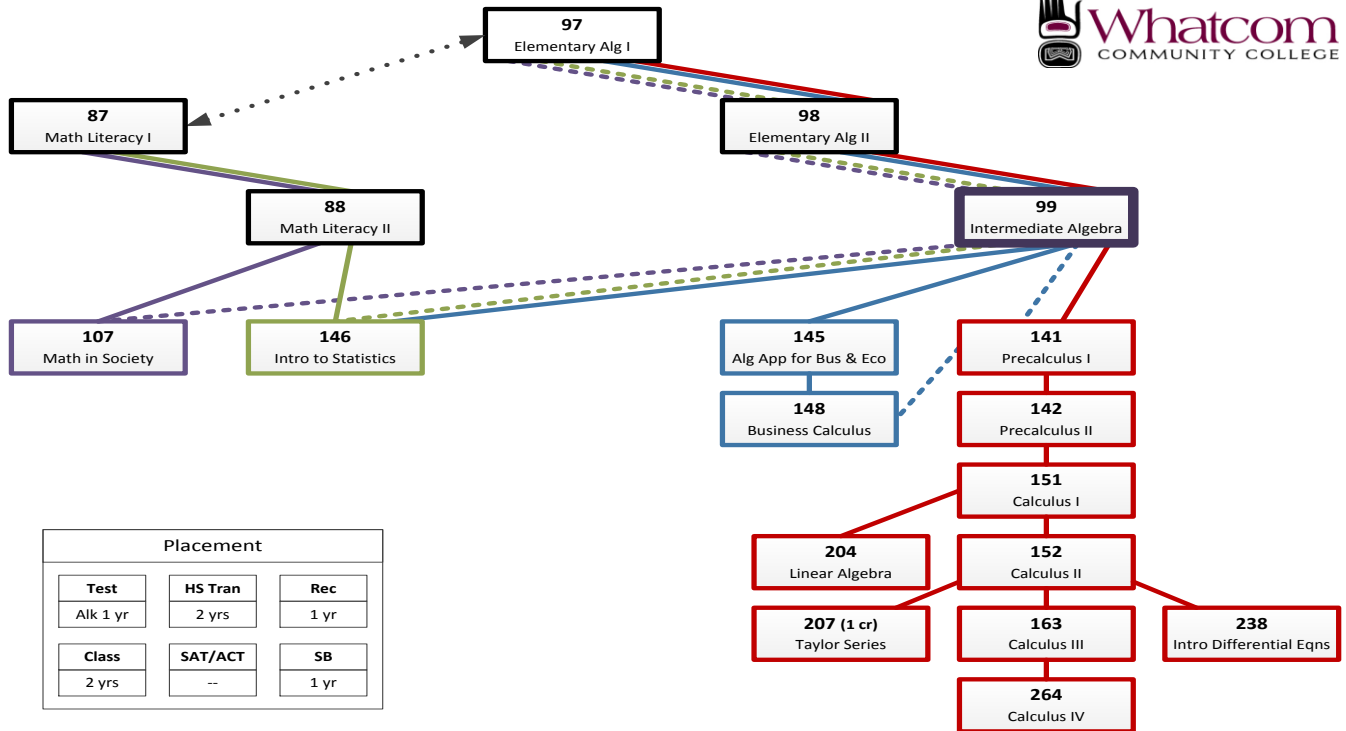

Placement		
<b>Test</b>	<b>HS Tran</b>	<b>Rec</b>
Alk 1 yr	2 yrs	1 yr
<b>Class</b>	<b>SAT/ACT</b>	<b>SB</b>
2 yrs	--	1 yr

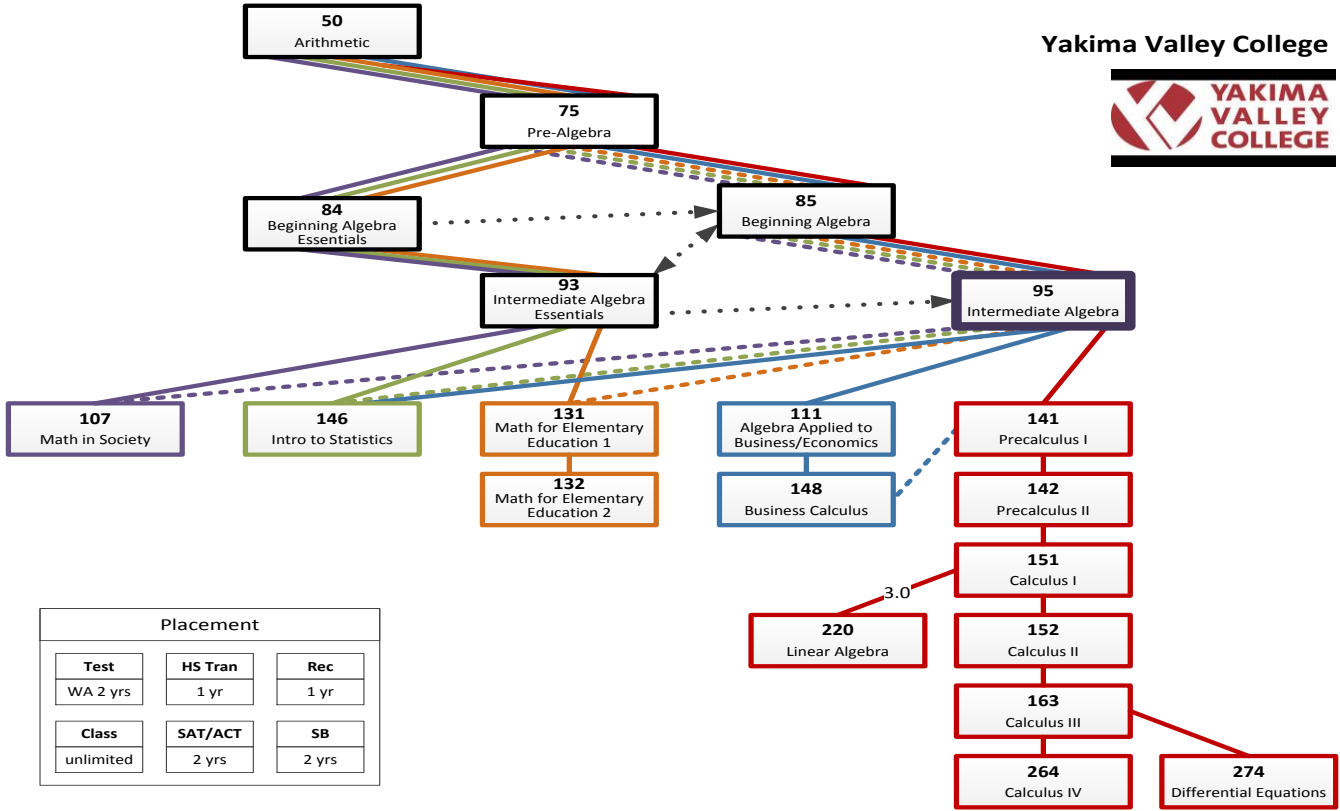

Placement		
<b>Test</b>	<b>HS Tran</b>	<b>Rec</b>
WA 2 yrs	1 yr	1 yr
<b>Class</b>	<b>SAT/ACT</b>	<b>SB</b>
unlimited	2 yrs	2 yrs

AP/IB Credit		
AP-AB	3,4,5	M172
AP-BC	3,4,5	M172&M173
AP-Stats	3,4,5	M311
IB	--	--

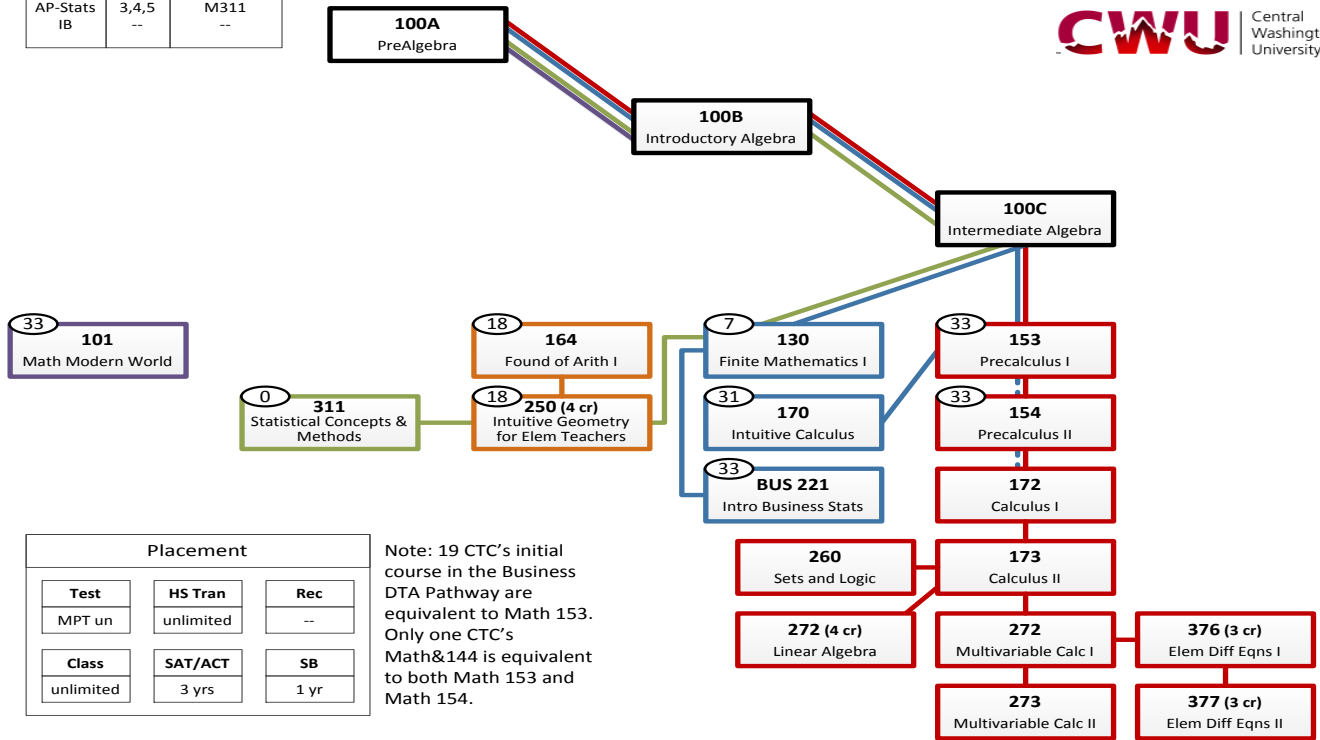

Placement		
<b>Test</b>	<b>HS Tran</b>	<b>Rec</b>
MPT un	unlimited	--
<b>Class</b>	<b>SAT/ACT</b>	<b>SB</b>
unlimited	3 yrs	1 yr

Note: 19 CTC's initial course in the Business DTA Pathway are equivalent to Math 153. Only one CTC's Math&144 is equivalent to both Math 153 and Math 154.

AP/IB Credit		
AP-AB	3,4,5	M142
AP-BC	3,4,5	M142
AP-Stats	3,4,5	M-Elec
IB	--	--

M-Elec = Math elective.

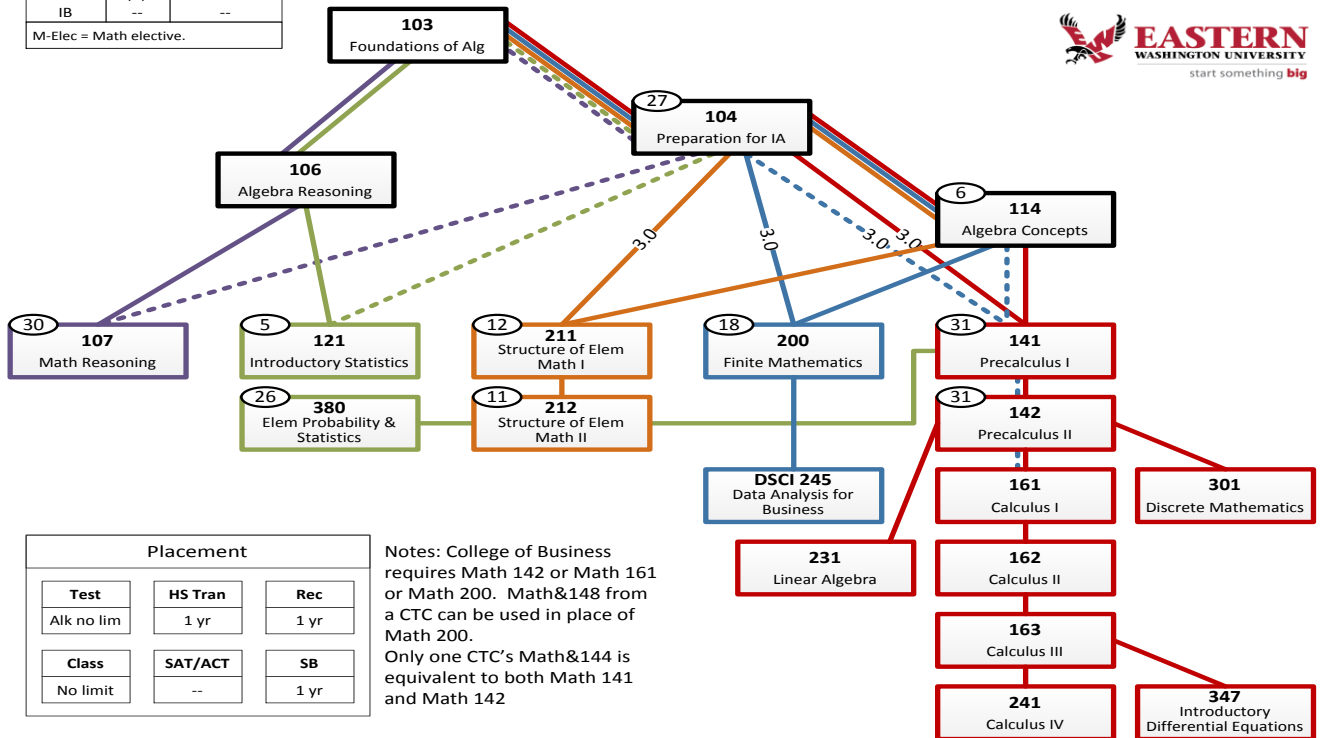

Placement		
<b>Test</b>	<b>HS Tran</b>	<b>Rec</b>
Alk no lim	1 yr	1 yr
<b>Class</b>	<b>SAT/ACT</b>	<b>SB</b>
No limit	--	1 yr

Notes: College of Business requires Math 142 or Math 161 or Math 200. Math&148 from a CTC can be used in place of Math 200. Only one CTC's Math&144 is equivalent to both Math 141 and Math 142

AP/IB Credit		
AP-AB	3,4,5	M151
AP-BC	3	M151
AP-Stats	4,5	M151&M152
IB	4,5	STAT231
	--	Gen Ed*

\*General Education credits are assessed to match students' academic goals.

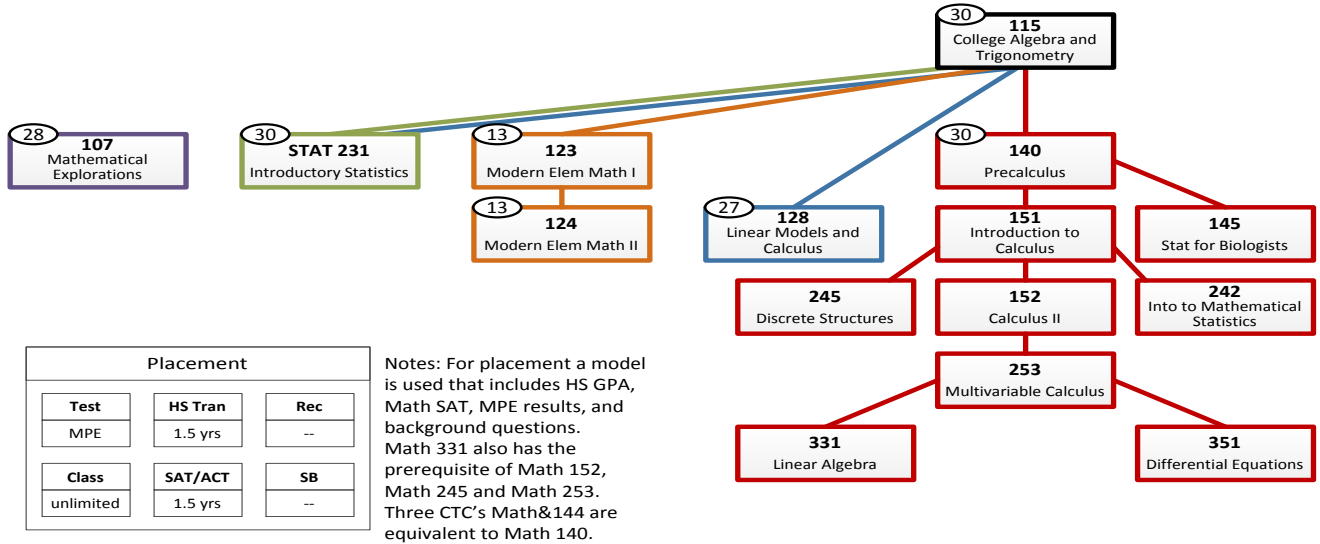

Placement		
<b>Test</b>	<b>HS Tran</b>	<b>Rec</b>
MPE	1.5 yrs	--
<b>Class</b>	<b>SAT/ACT</b>	<b>SB</b>
unlimited	1.5 yrs	--

Notes: For placement a model is used that includes HS GPA, Math SAT, MPE results, and background questions. Math 331 also has the prerequisite of Math 152, Math 245 and Math 253. Three CTC's Math&144 are equivalent to Math 140.

AP/IB Credit		
AP-AB	4,5	M1234
AP-BC	3	M1234*
AP-Stats	4,5	M1234&M1235
IB	4,5	M2360
	6,7	Quantitative Reasoning

\*with a subscore of at least 4

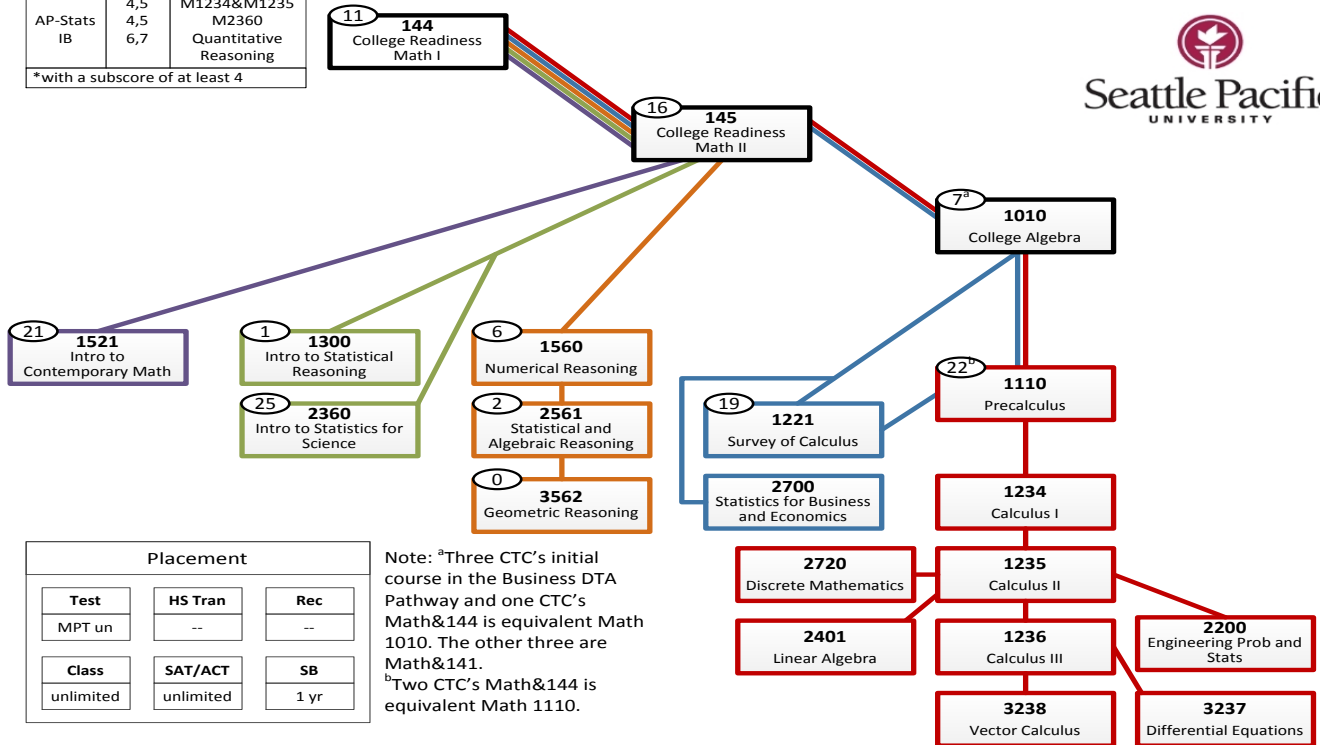

Placement		
<b>Test</b>	<b>HS Tran</b>	<b>Rec</b>
MPT un	--	--
<b>Class</b>	<b>SAT/ACT</b>	<b>SB</b>
unlimited	unlimited	1 yr

Note: <sup>a</sup>Three CTC's initial course in the Business DTA Pathway and one CTC's Math&144 is equivalent Math 1010. The other three are Math&141. <sup>b</sup>Two CTC's Math&144 is equivalent Math 1110.





AP/IB Credit		
AP-AB	3	M1130 or 1230
	4	M1334
	5	M1334&M1335
AP-BC	3	M1334
	4	M1334&M1335
	5	M1334&M1335
AP-Stats	3,4,5	M1210&ECON2100
IB	6,7	M1130 or M1230
IB-HL	5,6	M1130 or 1230 or 1334
	7	M1335

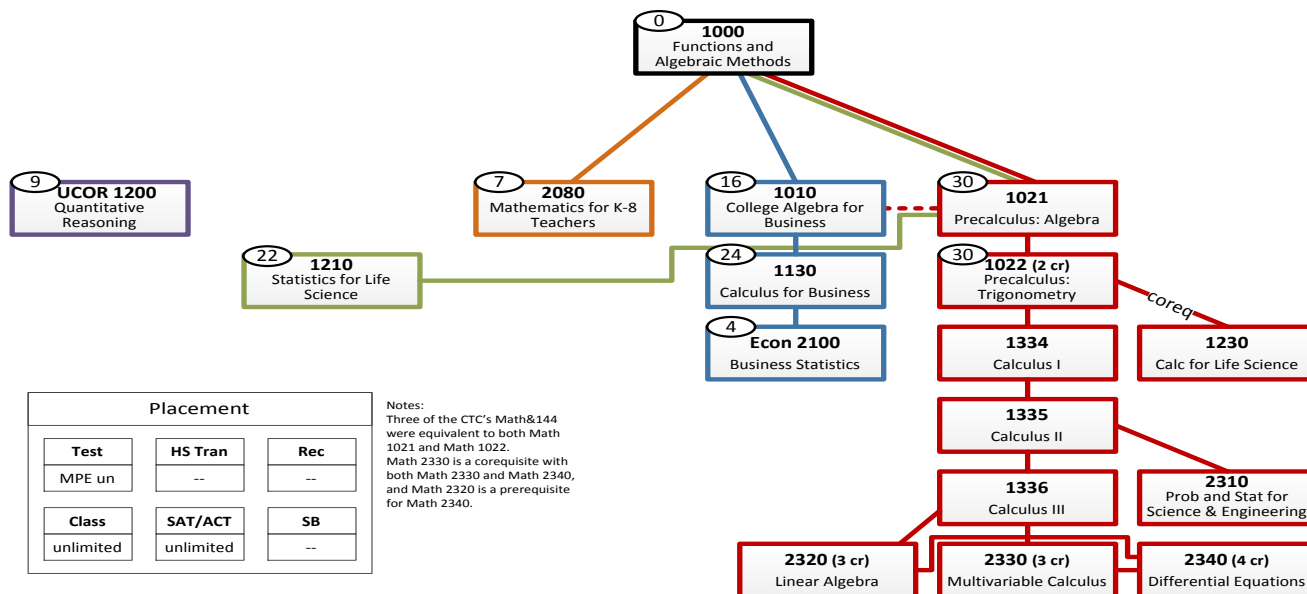

Placement		
<b>Test</b>	<b>HS Tran</b>	<b>Rec</b>
MPE un	--	--
<b>Class</b>	<b>SAT/ACT</b>	<b>SB</b>
unlimited	unlimited	--

Notes:  
 Three of the CTC's Math&144 were equivalent to both Math 1021 and Math 1022.  
 Math 2330 is a corequisite with both Math 2330 and Math 2340, and Math 2320 is a prerequisite for Math 2340.

AP/IB Credit		
AP-AB	2	M124*
	3,4	M124
	5	M124&M125
AP-BC	2	M124**
	3	M124
	4,5	M124&M125
AP-Stats	3,4,5	Stat311
IB	5,6	M120
	7	M124

\*Placement only.  
 \*\*In conjunction with a subgrade of 3, 4, or 5.

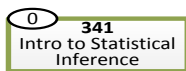

Note: Advisors at UW Bothell are currently working on equivalency guides for the CTCs.

Placement		
<b>Test</b>	<b>HS Tran</b>	<b>Rec</b>
MPT	--	--
<b>Class</b>	<b>SAT/ACT</b>	<b>SB</b>
unlimited	--	--

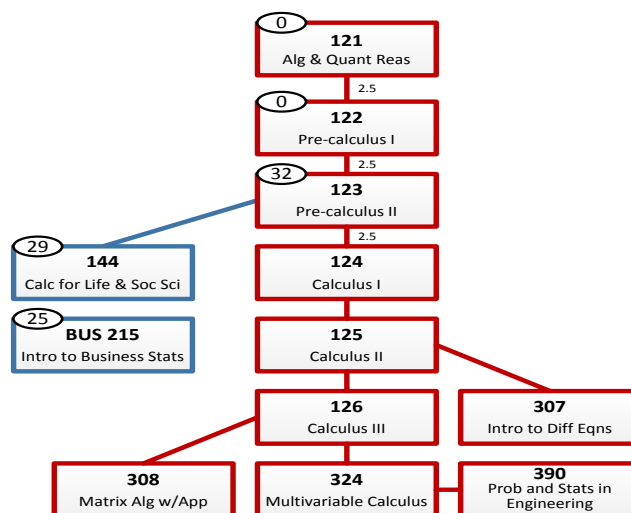

AP/IB Credit		
AP-AB	2	M120*
	3,4	M124
	5	M124&M125
AP-BC	2	M124**
	3	M124
	4,5	M124&M125
AP-Stats	3,4,5	Stat311
IB	5,6	M120
	7	M124

\*Placement only.  
 \*\*In conjunction with a subgrade of 3, 4, or 5.

University of Washington--Seattle

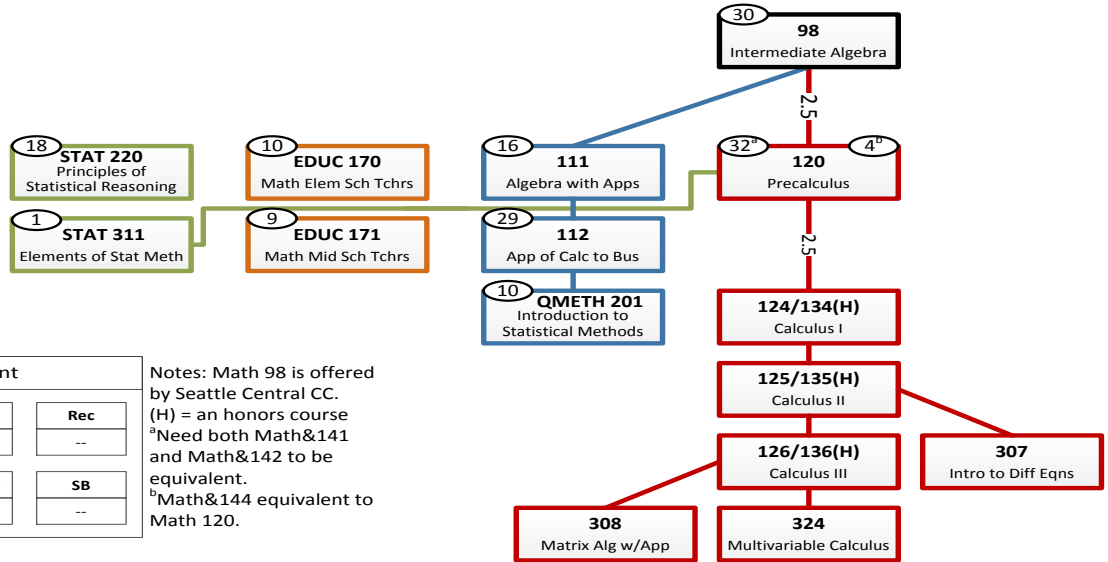

Placement		
Test	HS Tran	Rec
MPT 2 yrs	--	--
Class	SAT/ACT	SB
unlimited	--	--

Notes: Math 98 is offered by Seattle Central CC.  
 (H) = an honors course  
<sup>a</sup>Need both Math&141 and Math&142 to be equivalent.  
<sup>b</sup>Math&144 equivalent to Math 120.

AP/IB Credit		
AP-AB	2	M124*
	3,4	M124
	5	M124&M125
AP-BC	2	M124**
	3	M124
	4,5	M124&M125
AP-Stats	3,4,5	Stat311
IB	5,6	M120
	7	M124

\*Placement only.  
 \*\*In conjunction with a subgrade of 3, 4, or 5.

University of Washington--Tacoma



UNIVERSITY of WASHINGTON | TACOMA

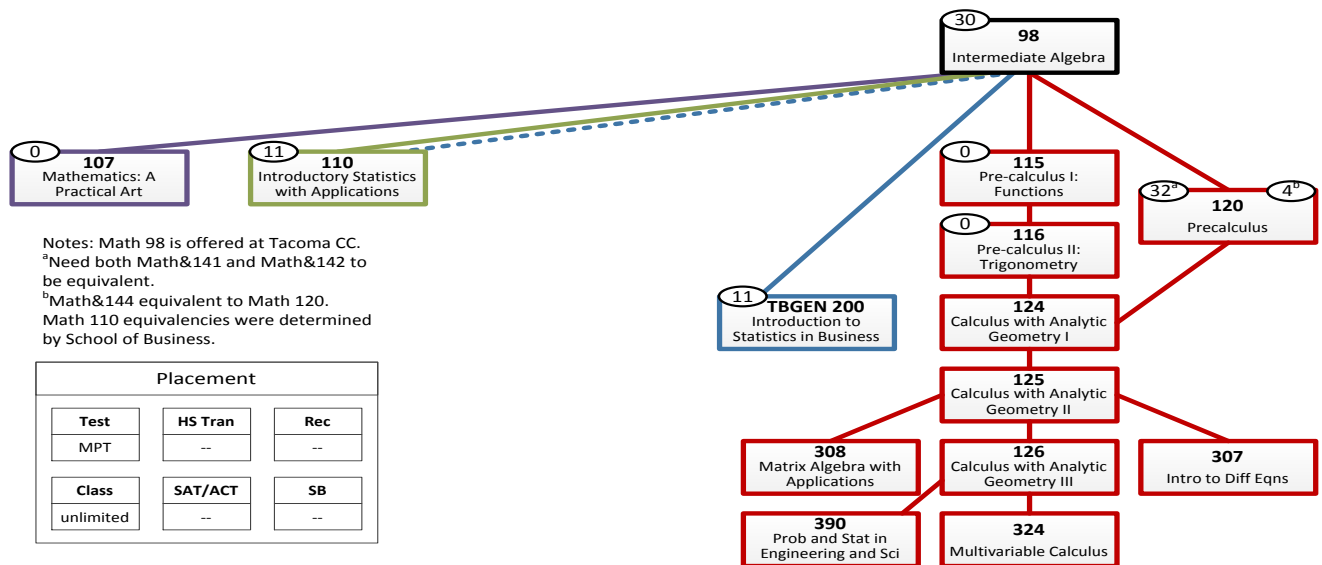

Notes: Math 98 is offered at Tacoma CC.  
<sup>a</sup>Need both Math&141 and Math&142 to be equivalent.  
<sup>b</sup>Math&144 equivalent to Math 120.  
 Math 110 equivalencies were determined by School of Business.

Placement		
Test	HS Tran	Rec
MPT	--	--
Class	SAT/ACT	SB
unlimited	--	--

AP/IB Credit		
AP-AB	2	M120*or M171*
	3,4	M171
	5	M171&M172
AP-BC	2	M171**
	3,4,5	M171&M172
AP-Stats	3,4,5	M212
IB	4+	M106&M108

\*Placement only.  
\*\*In conjunction with a subgrade of 3, 4, or 5.

Washington State University



WASHINGTON STATE UNIVERSITY

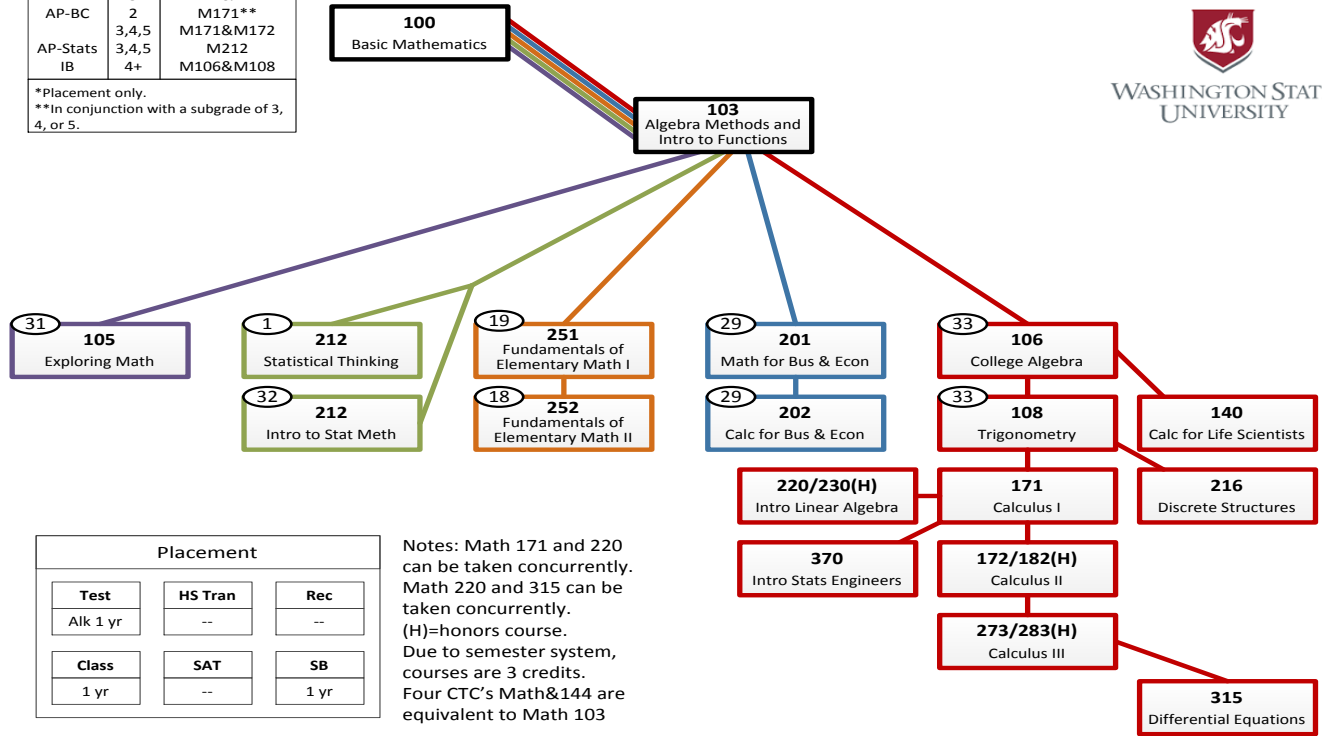

Placement		
<b>Test</b>	<b>HS Tran</b>	<b>Rec</b>
Alk 1 yr	--	--
<b>Class</b>	<b>SAT</b>	<b>SB</b>
1 yr	--	1 yr

Notes: Math 171 and 220 can be taken concurrently. Math 220 and 315 can be taken concurrently. (H)=honors course. Due to semester system, courses are 3 credits. Four CTC's Math&144 are equivalent to Math 103

AP/IB Credit		
AP-AB	3	M-Elect
AP-BC	3	M-Elect
AP-Stats	3	M240
IB	4	M-Elect

Western Washington University

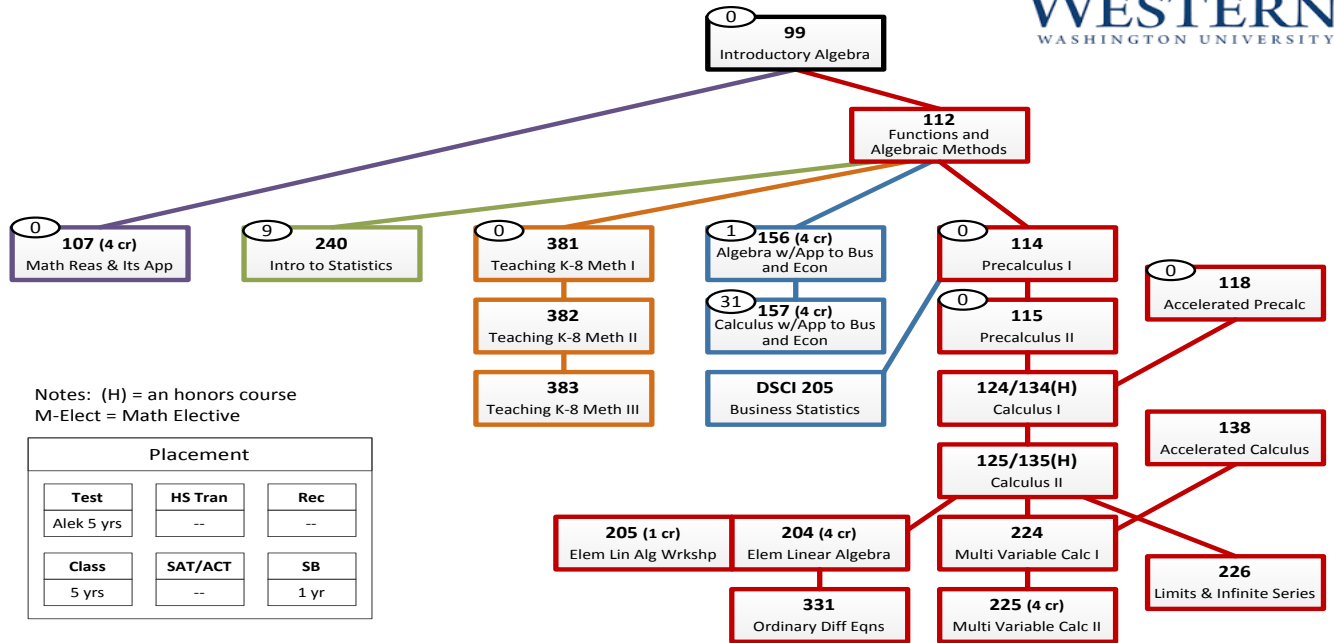

Notes: (H) = an honors course  
M-Elect = Math Elective

Placement		
<b>Test</b>	<b>HS Tran</b>	<b>Rec</b>
Alek 5 yrs	--	--
<b>Class</b>	<b>SAT/ACT</b>	<b>SB</b>
5 yrs	--	1 yr

## Appendix

The following are the flowcharts for colleges that have made changes to their math programs for the 2017-18 academic year: Bellevue College, Everett Community College, and Walla Walla Community College.

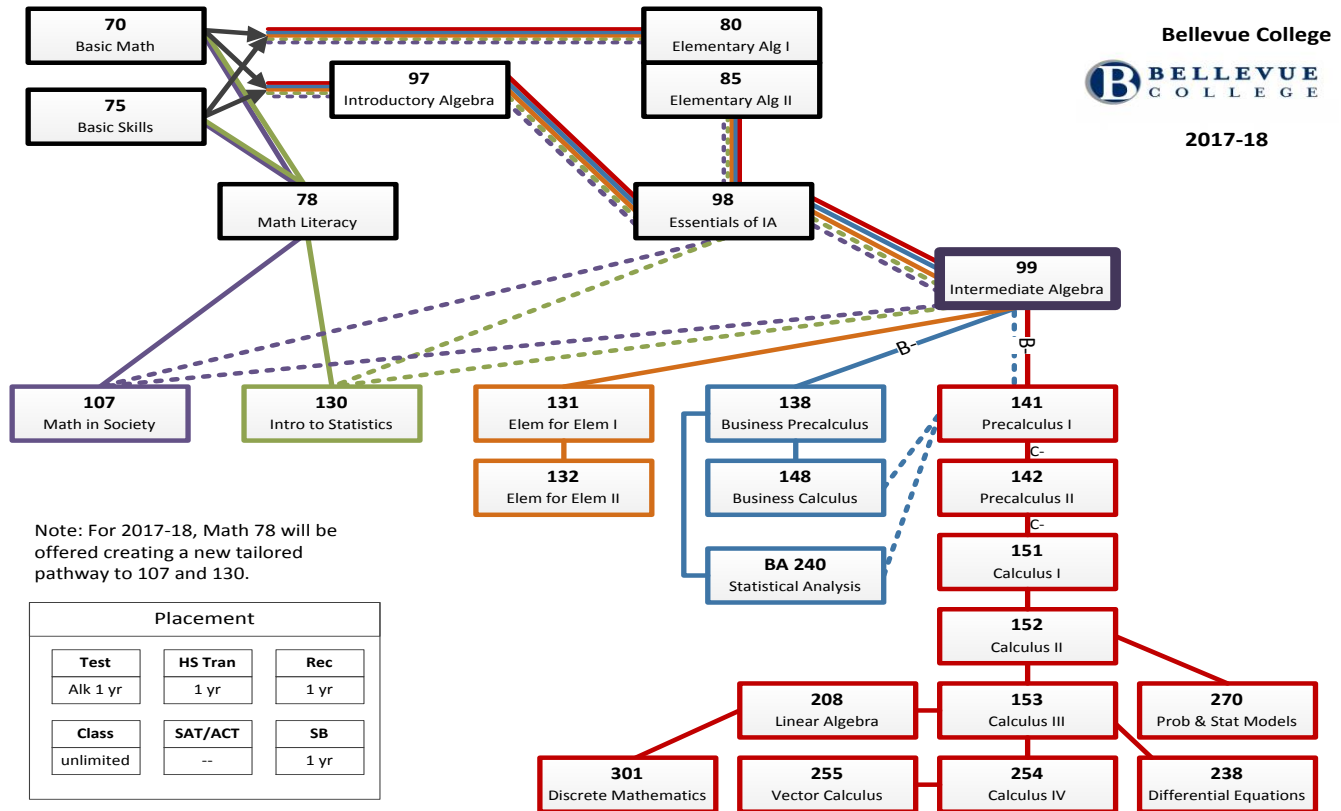

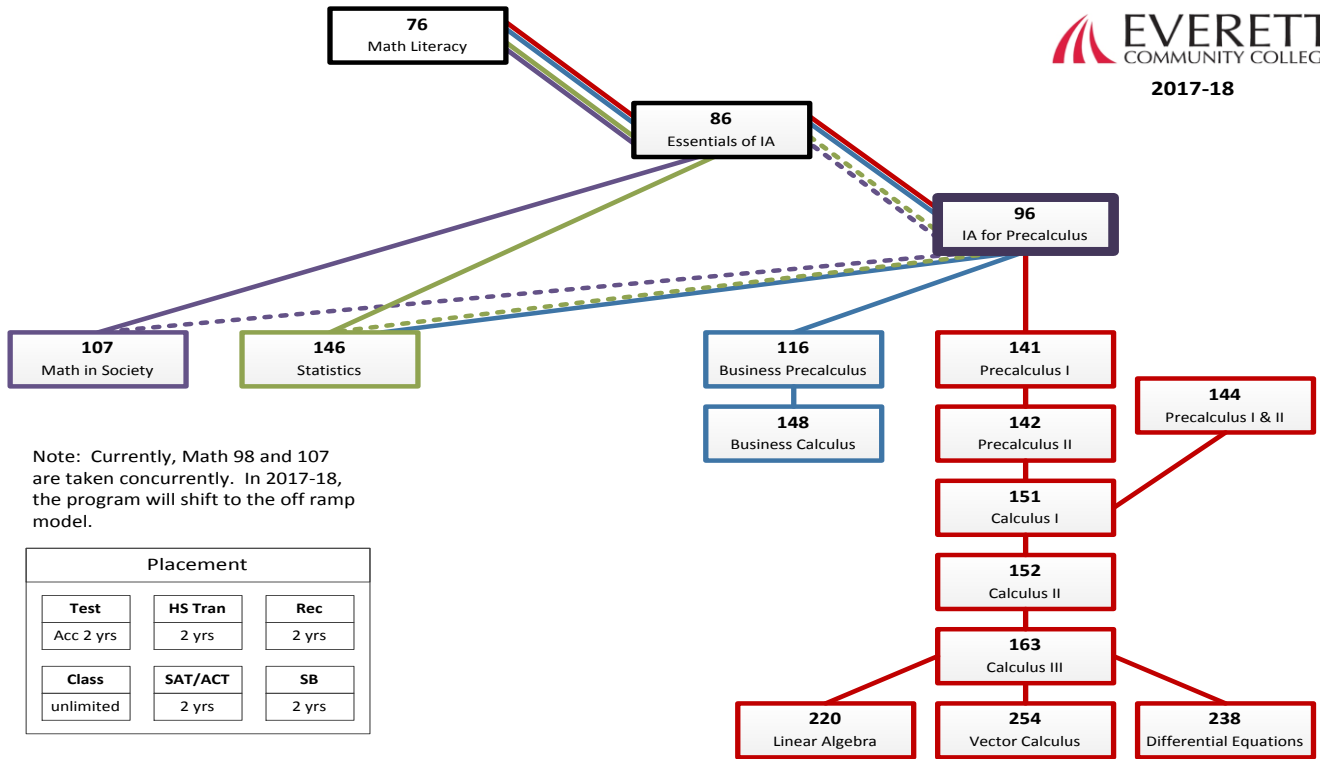

Note: Currently, Math 98 and 107 are taken concurrently. In 2017-18, the program will shift to the off ramp model.

Placement		
<b>Test</b>	<b>HS Tran</b>	<b>Rec</b>
Acc 2 yrs	2 yrs	2 yrs
<b>Class</b>	<b>SAT/ACT</b>	<b>SB</b>
unlimited	2 yrs	2 yrs

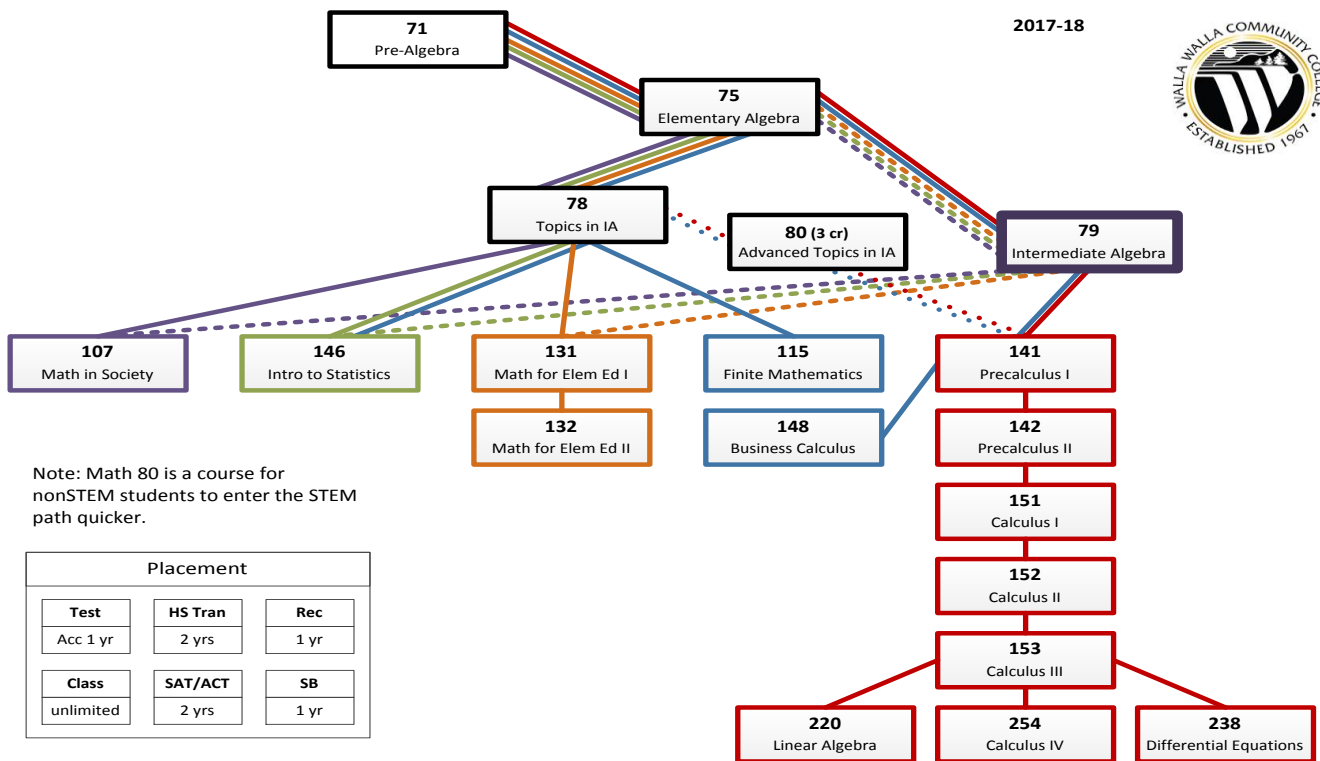

Note: Math 80 is a course for nonSTEM students to enter the STEM path quicker.

Placement		
<b>Test</b>	<b>HS Tran</b>	<b>Rec</b>
Acc 1 yr	2 yrs	1 yr
<b>Class</b>	<b>SAT/ACT</b>	<b>SB</b>
unlimited	2 yrs	1 yr